

# Statistical Physics

University of Cambridge Part II Mathematical Tripos

---

**Dr David Tong**

*Department of Applied Mathematics and Theoretical Physics,  
Centre for Mathematical Sciences,  
Wilberforce Road,  
Cambridge, CB3 0BA, UK*

<http://www.damtp.cam.ac.uk/user/tong/statphys.html>  
[d.tong@damtp.cam.ac.uk](mailto:d.tong@damtp.cam.ac.uk)

## Recommended Books and Resources

- Reif, *Fundamentals of Statistical and Thermal Physics*

A comprehensive and detailed account of the subject. It's solid. It's good. It isn't quirky.

- Kardar, *Statistical Physics of Particles*

A modern view on the subject which offers many insights. It's superbly written, if a little brief in places. A companion volume, "*The Statistical Physics of Fields*" covers aspects of critical phenomena. Both are available to download as lecture notes. Links are given on the course webpage

- Landau and Lifshitz, *Statistical Physics*

Russian style: terse, encyclopedic, magnificent. Much of this book comes across as remarkably modern given that it was first published in 1958.

- Mandl, *Statistical Physics*

This is an easy going book with very clear explanations but doesn't go into as much detail as we will need for this course. If you're struggling to understand the basics, this is an excellent place to look. If you're after a detailed account of more advanced aspects, you should probably turn to one of the books above.

- Pippard, *The Elements of Classical Thermodynamics*

This beautiful little book walks you through the rather subtle logic of classical thermodynamics. It's very well done. If Arnold Sommerfeld had read this book, he would have understood thermodynamics the first time round.

There are many other excellent books on this subject, often with different emphasis. I recommend "*States of Matter*" by David Goodstein which covers several topics beyond the scope of this course but offers many insights. For an entertaining yet technical account of thermodynamics that lies somewhere between a textbook and popular science, read "*The Four Laws*" by Peter Atkins.

A number of good lecture notes are available on the web. Links can be found on the course webpage: <http://www.damtp.cam.ac.uk/user/tong/statphys.html>

---

## Contents

|  |           |
|--|-----------|
| <b>1. The Fundamentals of Statistical Mechanics</b>            | <b>1</b>  |
| 1.1 Introduction   | 1         |
| 1.2 The Microcanonical Ensemble                                | 2         |
| 1.2.1 Entropy and the Second Law of Thermodynamics             | 5         |
| 1.2.2 Temperature  | 8         |
| 1.2.3 An Example: The Two State System                         | 11        |
| 1.2.4 Pressure, Volume and the First Law of Thermodynamics     | 14        |
| 1.2.5 Ludwig Boltzmann (1844-1906)                             | 16        |
| 1.3 The Canonical Ensemble                                     | 17        |
| 1.3.1 The Partition Function                                   | 18        |
| 1.3.2 Energy and Fluctuations                                  | 19        |
| 1.3.3 Entropy  | 22        |
| 1.3.4 Free Energy  | 25        |
| 1.4 The Chemical Potential                                     | 26        |
| 1.4.1 Grand Canonical Ensemble                                 | 27        |
| 1.4.2 Grand Canonical Potential                                | 29        |
| 1.4.3 Extensive and Intensive Quantities                       | 29        |
| 1.4.4 Josiah Willard Gibbs (1839-1903)                         | 30        |
| <br>   |           |
| <b>2. Classical Gases</b>                                      | <b>31</b> |
| 2.1 The Classical Partition Function                           | 31        |
| 2.1.1 From Quantum to Classical                                | 32        |
| 2.2 Ideal Gas  | 33        |
| 2.2.1 Equipartition of Energy                                  | 36        |
| 2.2.2 The Sociological Meaning of Boltzmann's Constant         | 36        |
| 2.2.3 Entropy and Gibbs's Paradox                              | 38        |
| 2.2.4 The Ideal Gas in the Grand Canonical Ensemble            | 39        |
| 2.3 Maxwell Distribution                                       | 40        |
| 2.3.1 A History of Kinetic Theory                              | 42        |
| 2.4 Diatomic Gas   | 44        |
| 2.5 Interacting Gas  | 47        |
| 2.5.1 The Mayer $f$ Function and the Second Virial Coefficient | 49        |
| 2.5.2 van der Waals Equation of State                          | 51        |
| 2.5.3 The Cluster Expansion                                    | 54        |

|           |  |            |
|-----------|--|------------|
| 2.6       | Screening and the Debye-Hückel Model of a Plasma     | 59         |
| <b>3.</b> | <b>Quantum Gases</b>                                 | <b>61</b>  |
| 3.1       | Density of States                                    | 61         |
| 3.1.1     | Relativistic Systems                                 | 62         |
| 3.2       | Photons: Blackbody Radiation                         | 63         |
| 3.2.1     | Planck Distribution                                  | 65         |
| 3.2.2     | The Cosmic Microwave Background Radiation            | 67         |
| 3.2.3     | The Birth of Quantum Mechanics                       | 68         |
| 3.2.4     | Max Planck (1858-1947)                               | 69         |
| 3.3       | Phonons  | 69         |
| 3.3.1     | The Debye Model                                      | 69         |
| 3.4       | The Diatomic Gas Revisited                           | 74         |
| 3.5       | Bosons   | 76         |
| 3.5.1     | Bose-Einstein Distribution                           | 77         |
| 3.5.2     | A High Temperature Quantum Gas is (Almost) Classical | 80         |
| 3.5.3     | Bose-Einstein Condensation                           | 81         |
| 3.5.4     | Heat Capacity: Our First Look at a Phase Transition  | 85         |
| 3.6       | Fermions   | 89         |
| 3.6.1     | Ideal Fermi Gas                                      | 90         |
| 3.6.2     | Degenerate Fermi Gas and the Fermi Surface           | 91         |
| 3.6.3     | The Fermi Gas at Low Temperature                     | 92         |
| 3.6.4     | A More Rigorous Approach: The Sommerfeld Expansion   | 96         |
| 3.6.5     | White Dwarfs and the Chandrasekhar limit             | 99         |
| 3.6.6     | Pauli Paramagnetism                                  | 101        |
| 3.6.7     | Landau Diamagnetism                                  | 103        |
| <b>4.</b> | <b>Classical Thermodynamics</b>                      | <b>107</b> |
| 4.1       | Temperature and the Zeroth Law                       | 108        |
| 4.2       | The First Law  | 110        |
| 4.3       | The Second Law                                       | 112        |
| 4.3.1     | The Carnot Cycle                                     | 114        |
| 4.3.2     | Thermodynamic Temperature Scale and the Ideal Gas    | 116        |
| 4.3.3     | Entropy  | 119        |
| 4.3.4     | Adiabatic Surfaces                                   | 122        |
| 4.3.5     | A History of Thermodynamics                          | 125        |
| 4.4       | Thermodynamic Potentials: Free Energies and Enthalpy | 127        |
| 4.4.1     | Enthalpy   | 130        |

|           |   |            |
|-----------|---|------------|
| 4.4.2     | Maxwell's Relations                                   | 130        |
| 4.5       | The Third Law   | 132        |
| <b>5.</b> | <b>Phase Transitions</b>                              | <b>134</b> |
| 5.1       | Liquid-Gas Transition                                 | 134        |
| 5.1.1     | Phase Equilibrium                                     | 136        |
| 5.1.2     | The Clausius-Clapeyron Equation                       | 139        |
| 5.1.3     | The Critical Point                                    | 141        |
| 5.2       | The Ising Model                                       | 146        |
| 5.2.1     | Mean Field Theory                                     | 148        |
| 5.2.2     | Critical Exponents                                    | 151        |
| 5.2.3     | Validity of Mean Field Theory                         | 153        |
| 5.3       | Some Exact Results for the Ising Model                | 154        |
| 5.3.1     | The Ising Model in $d = 1$ Dimensions                 | 155        |
| 5.3.2     | 2d Ising Model: Low Temperatures and Peierls Droplets | 156        |
| 5.3.3     | 2d Ising Model: High Temperatures                     | 161        |
| 5.3.4     | Kramers-Wannier Duality                               | 164        |
| 5.4       | Landau Theory   | 169        |
| 5.4.1     | Second Order Phase Transitions                        | 171        |
| 5.4.2     | First Order Phase Transitions                         | 174        |
| 5.4.3     | Lee-Yang Zeros  | 175        |
| 5.5       | Landau-Ginzburg Theory                                | 179        |
| 5.5.1     | Correlations  | 181        |
| 5.5.2     | Fluctuations  | 182        |

---

## **Acknowledgements**

These lecture notes are far from original. They borrow heavily both from the books described above and the online resources listed on the course webpage. I benefited a lot from the lectures by Mehran Kardar and by Chetan Nayak. This course is built on the foundation of previous courses given in Cambridge by Ron Horgan and Matt Wingate. I am also grateful to Ray Goldstein for help in developing the present syllabus. I am supported by the Royal Society and Alex Considine.

# 1. The Fundamentals of Statistical Mechanics

“Ludwig Boltzmann, who spent much of his life studying statistical mechanics, died in 1906 by his own hand. Paul Ehrenfest, carrying on the work, died similarly in 1933. Now it is our turn to study statistical mechanics.”

*David Goodstein*

## 1.1 Introduction

Statistical mechanics is the art of turning the microscopic laws of physics into a description of Nature on a macroscopic scale.

Suppose you’ve got theoretical physics cracked. Suppose you know all the fundamental laws of Nature, the properties of the elementary particles and the forces at play between them. How can you turn this knowledge into an understanding of the world around us? More concretely, if I give you a box containing  $10^{23}$  particles and tell you their mass, their charge, their interactions, and so on, what can you tell me about the stuff in the box?

There’s one strategy that definitely won’t work: writing down the Schrödinger equation for  $10^{23}$  particles and solving it. That’s typically not possible for 23 particles, let alone  $10^{23}$ . What’s more, even if you could find the wavefunction of the system, what would you do with it? The positions of individual particles are of little interest to anyone. We want answers to much more basic, almost childish, questions about the contents of the box. Is it wet? Is it hot? What colour is it? Is the box in danger of exploding? What happens if we squeeze it, pull it, heat it up? How can we begin to answer these kind of questions starting from the fundamental laws of physics?

The purpose of this course is to introduce the dictionary that allows you translate from the microscopic world where the laws of Nature are written to the everyday macroscopic world that we’re familiar with. This will allow us to begin to address very basic questions about how matter behaves.

We’ll see many examples. For centuries — from the 1600s to the 1900s — scientists were discovering “laws of physics” that govern different substances. There are many hundreds of these laws, mostly named after their discoverers. Boyle’s law and Charles’s law relate pressure, volume and temperature of gases (they are usually combined into the ideal gas law); the Stefan-Boltzmann law tells you how much energy a hot object emits; Wien’s displacement law tells you the colour of that hot object; the Dulong-Petit

law tells you how much energy it takes to heat up a lump of stuff; Curie’s law tells you how a magnet loses its magic if you put it over a flame; and so on and so on. Yet we now know that these laws aren’t fundamental. In some cases they follow simply from Newtonian mechanics and a dose of statistical thinking. In other cases, we need to throw quantum mechanics into the mix as well. But in all cases, we’re going to see how derive them from first principles.

A large part of this course will be devoted to figuring out the interesting things that happen when you throw  $10^{23}$  particles together. One of the recurring themes will be that  $10^{23} \neq 1$ . More is different: there are key concepts that are not visible in the underlying laws of physics but emerge only when we consider a large collection of particles. One very simple example is temperature. This is not a fundamental concept: it doesn’t make sense to talk about the temperature of a single electron. But it would be impossible to talk about physics of the everyday world around us without mention of temperature. This illustrates the fact that the language needed to describe physics on one scale is very different from that needed on other scales. We’ll see several similar emergent quantities in this course, including the phenomenon of phase transitions where the smooth continuous laws of physics conspire to give abrupt, discontinuous changes in the structure of matter.

Historically, the techniques of statistical mechanics proved to be a crucial tool for understanding the deeper laws of physics. Not only is the development of the subject intimately tied with the first evidence for the existence of atoms, but quantum mechanics itself was discovered by applying statistical methods to decipher the spectrum of light emitted from hot objects. (We will study this derivation in Section 3). However, physics is not a finished subject. There are many important systems in Nature – from high temperature superconductors to black holes – which are not yet understood at a fundamental level. The information that we have about these systems concerns their macroscopic properties and our goal is to use these scant clues to deconstruct the underlying mechanisms at work. The tools that we will develop in this course will be crucial in this task.

## 1.2 The Microcanonical Ensemble

“Anyone who wants to analyze the properties of matter in a real problem might want to start by writing down the fundamental equations and then try to solve them mathematically. Although there are people who try to use such an approach, these people are the failures in this field. . .”

*Richard Feynman, sugar coating it.*



We'll start by considering an isolated system with fixed energy,  $E$ . For the purposes of the discussion we will describe our system using the language of quantum mechanics, although we should keep in mind that nearly everything applies equally well to classical systems.

In your first two courses on quantum mechanics you looked only at systems with a few degrees of freedom. These are defined by a Hamiltonian,  $\hat{H}$ , and the goal is usually to solve the time independent Schrödinger equation

$$\hat{H}|\psi\rangle = E|\psi\rangle$$

In this course, we will still look at systems that are defined by a Hamiltonian, but now with a very large number of degrees of freedom, say  $N \sim 10^{23}$ . The energy eigenstates  $|\psi\rangle$  are very complicated objects since they contain information about what each of these particles is doing. They are called *microstates*.

In practice, it is often extremely difficult to write down the microstate describing all these particles. But, more importantly, it is usually totally uninteresting. The wavefunction for a macroscopic system very rarely captures the relevant physics because real macroscopic systems are not described by a single pure quantum state. They are in contact with an environment, constantly buffeted and jostled by outside influences. Each time the system is jogged slightly, it undergoes a small perturbation and there will be a probability that it transitions to another state. If the perturbation is very small, then the transitions will only happen to states of equal (or very nearly equal) energy. But with  $10^{23}$  particles, there can be many many microstates all with the same energy  $E$ . To understand the physics of these systems, we don't need to know the intimate details of any one state. We need to know the crude details of all the states.

It would be impossibly tedious to keep track of the dynamics which leads to transitions between the different states. Instead we will resort to statistical methods. We will describe the system in terms of a probability distribution over the quantum states. In other words, the system is in a *mixed state* rather than a pure state. Since we have fixed the energy, there will only be a non-zero probability for states which have the specified energy  $E$ . We will denote a basis of these states as  $|n\rangle$  and the probability that the systems sits in a given state as  $p(n)$ . Within this probability distribution, the expectation value of any operator  $\hat{O}$  is

$$\langle \hat{O} \rangle = \sum_n p(n) \langle n | \hat{O} | n \rangle$$

Our immediate goal is to understand what probability distribution  $p(n)$  is appropriate for large systems.

Firstly, we will greatly restrict the kind of situations that we can talk about. We will only discuss systems that have been left alone for some time. This ensures that the energy and momentum in the system has been redistributed among the many particles and any memory of whatever special initial conditions the system started in has long been lost. Operationally, this means that the probability distribution is independent of time which ensures that the expectation values of the macroscopic observables are also time independent. In this case, we say that the system is in *equilibrium*. Note that just because the system is in equilibrium does not mean that all the components of the system have stopped moving; a glass of water left alone will soon reach equilibrium but the atoms inside are still flying around.

We are now in a position to state the fundamental assumption of statistical mechanics. It is the idea that we should take the most simple minded approach possible and treat all states the same. Or, more precisely:

*For an isolated system in equilibrium, all accessible microstates are equally likely.*

Since we know nothing else about the system, such a democratic approach seems eminently reasonable. Notice that we've left ourselves a little flexibility with the inclusion of the word "accessible". This refers to any state that can be reached due to the small perturbations felt by the system. For the moment, we will take it mean all states that have the same energy  $E$ . Later, we shall see contexts where we add further restrictions on what it means to be an accessible state.

Let us introduce some notation. We define

$$\Omega(E) = \text{Number of states with energy } E$$

The probability that the system with fixed energy  $E$  is in a given state  $|n\rangle$  is simply

$$p(n) = \frac{1}{\Omega(E)} \tag{1.1}$$

The probability that the system is in a state with some different energy  $E' \neq E$  is zero. This probability distribution, relevant for systems with fixed energy, is known as the *microcanonical ensemble*. Some comments:

- $\Omega(E)$  is a usually ridiculously large number. For example, suppose that we have  $N \sim 10^{23}$  particles, each of which can only be in one of two quantum states – say “spin up” and “spin down”. Then the total number of microstates of the system is  $2^{10^{23}}$ . This is a silly number. In some sense, numbers this large can never have

any physical meaning! They only appear in combinatoric problems, counting possible eventualities. They are never answers to problems which require you to count actual existing physical objects. One, slightly facetious, way of saying this is that numbers this large can't have physical meaning because they are the same no matter what units they have. (If you don't believe me, think of  $2^{10^{23}}$  as a distance scale: it is effectively the same distance regardless of whether it is measured in microns or lightyears. Try it!).

- In quantum systems, the energy levels will be discrete. However, with many particles the energy levels will be finely spaced and can be effectively treated as a continuum. When we say that  $\Omega(E)$  counts the number of states with energy  $E$  we implicitly mean that it counts the number of states with energy between  $E$  and  $E + \delta E$  where  $\delta E$  is small compared to the accuracy of our measuring apparatus but large compared to the spacing of the levels.
- We phrased our discussion in terms of quantum systems but everything described above readily carries over the classical case. In particular, the probabilities  $p(n)$  have nothing to do with quantum indeterminacy. They are due entirely to our ignorance.

### 1.2.1 Entropy and the Second Law of Thermodynamics

We define the *entropy* of the system to be

$$S(E) = k_B \log \Omega(E) \tag{1.2}$$

Here  $k_B$  is a fundamental constant, known as *Boltzmann's constant*. It has units of Joules per Kelvin.

$$k_B \approx 1.381 \times 10^{-23} \text{JK}^{-1} \tag{1.3}$$

The log in (1.2) is the natural logarithm (base  $e$ , not base 10). Why do we take the log in the definition? One reason is that it makes the numbers less silly. While the number of states is of order  $\Omega \sim e^N$ , the entropy is merely proportional to the number of particles in the system,  $S \sim N$ . This also has the happy consequence that the entropy is an additive quantity. To see this, consider two non-interacting systems with energies  $E_1$  and  $E_2$  respectively. Then the total number of states of both systems is

$$\Omega(E_1, E_2) = \Omega_1(E_1)\Omega(E_2)$$

while the entropy for both systems is

$$S(E_1, E_2) = S_1(E_1) + S_2(E_2)$$

## The Second Law

Suppose we take the two, non-interacting, systems mentioned above and we bring them together. We'll assume that they can exchange energy, but that the energy levels of each individual system remain unchanged. (These are actually contradictory assumptions! If the systems can exchange energy then there must be an interaction term in their Hamiltonian. But such a term would shift the energy levels of each system. So what we really mean is that these shifts are negligibly small and the only relevant effect of the interaction is to allow the energy to move between systems).

The energy of the combined system is still  $E_{\text{total}} = E_1 + E_2$ . But the first system can have any energy  $E \leq E_{\text{total}}$  while the second system must have the remainder  $E_{\text{total}} - E$ . In fact, there is a slight caveat to this statement: in a quantum system we can't have any energy at all: only those discrete energies  $E_i$  that are eigenvalues of the Hamiltonian. So the number of available states of the combined system is

$$\begin{aligned}\Omega(E_{\text{total}}) &= \sum_{\{E_i\}} \Omega_1(E_i)\Omega_2(E_{\text{total}} - E_i) \\ &= \sum_{\{E_i\}} \exp\left(\frac{S_1(E_i)}{k_B} + \frac{S_2(E_{\text{total}} - E_i)}{k_B}\right)\end{aligned}\tag{1.4}$$

There is a slight subtlety in the above equation. Both system 1 and system 2 have discrete energy levels. How do we know that if  $E_i$  is an energy of system 1 then  $E_{\text{total}} - E_i$  is an energy of system 2. In part this goes back to the comment made above about the need for an interaction Hamiltonian that shifts the energy levels. In practice, we will just ignore this subtlety. In fact, for most of the systems that we will discuss in this course, the discreteness of energy levels will barely be important since they are so finely spaced that we can treat the energy  $E$  of the first system as a continuous variable and replace the sum by an integral. We will see many explicit examples of this in the following sections.

At this point, we turn again to our fundamental assumption — all states are equally likely — but now applied to the combined system. This has fixed energy  $E_{\text{total}}$  so can be thought of as sitting in the microcanonical ensemble with the distribution (1.1) which means that the system has probability  $p = 1/\Omega(E_{\text{total}})$  to be in each state. Clearly, the entropy of the combined system is greater or equal to that of the original system,

$$S(E_{\text{total}}) \equiv k_B \log \Omega(E_{\text{total}}) \geq S_1(E_1) + S_2(E_2)\tag{1.5}$$

which is true simply because the states of the two original systems are a subset of the total number of possible states.

While (1.5) is true for any two systems, there is a useful approximation we can make to determine  $S(E_{\text{total}})$  which holds when the number of particles,  $N$ , in the game is very large. We have already seen that the entropy scales as  $S \sim N$ . This means that the expression (1.4) is a sum of exponentials of  $N$ , which is itself an exponentially large number. Such sums are totally dominated by their maximum value. For example, suppose that for some energy,  $E_*$ , the exponent has a value that's twice as large as any other  $E$ . Then this term in the sum is larger than all the others by a factor of  $e^N$ . And that's a very large number. All terms but the maximum are completely negligible. (The equivalent statement for integrals is that they can be evaluated using the saddle point method). In our case, the maximum value,  $E = E_*$ , occurs when

$$\frac{\partial S_1(E_*)}{\partial E} - \frac{\partial S_2(E_{\text{total}} - E_*)}{\partial E} = 0 \quad (1.6)$$

where this slightly cumbersome notation means (for the first term)  $\partial S_1/\partial E$  evaluated at  $E = E_*$ . The total entropy of the combined system can then be very well approximated by

$$S(E_{\text{total}}) \approx S_1(E_*) + S_2(E_{\text{total}} - E_*) \geq S_1(E_1) + S_2(E_2)$$

It's worth stressing that there is no a priori reason why the first system should have a fixed energy once it is in contact with the second system. But the large number of particles involved means that it is overwhelmingly likely to be found with energy  $E_*$  which maximises the number of states of the combined system. Conversely, once in this bigger set of states, it is highly unlikely that the system will ever be found back in a state with energy  $E_1$  or, indeed, any other energy different from  $E_*$ .

It is this simple statement that is responsible for all the irreversibility that we see in the world around us. This is the *second law of thermodynamics*. As a slogan, “entropy increases”. When two systems are brought together — or, equivalently, when constraints on a system are removed — the total number of available states available is vastly enlarged.

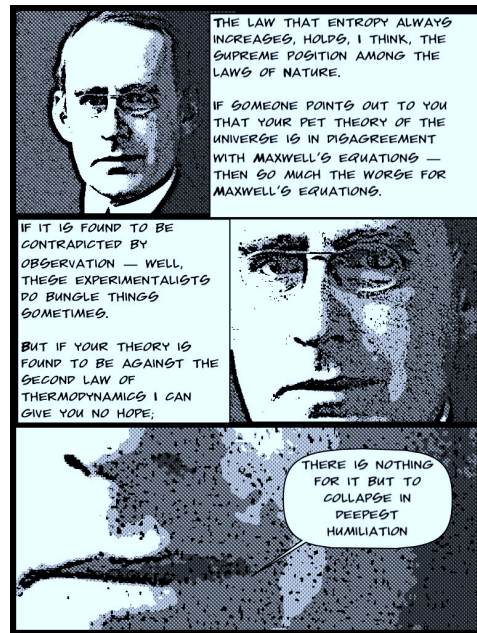

Figure 1: Arthur Eddington

It is sometimes stated that second law is the most sacred in all of physics. Arthur Eddington’s rant, depicted in the cartoon, is one of the more famous acclamations of the law.

And yet, as we have seen above, the second law hinges on probabilistic arguments. We said, for example, that it is “highly unlikely” that the system will return to its initial configuration. One might think that this may allow us a little leeway. Perhaps, if probabilities are underlying the second law, we can sometimes get lucky and find counterexamples. While, it is most likely to find system 1 to have energy  $E_*$ , surely occasionally one sees it in a state with a different energy? In fact, this never happens. The phrase “highly unlikely” is used only because the English language does not contain enough superlatives to stress how ridiculously improbable a violation of the second law would be. The silly number of possible states in a macroscopic systems means that violations happen only on silly time scales: exponentials of exponentials. This is a good operational definition of the word “never”.

### 1.2.2 Temperature

We next turn to a very familiar quantity, albeit viewed in an unfamiliar way. The temperature,  $T$ , of a system is defined as

$$\frac{1}{T} = \frac{\partial S}{\partial E} \tag{1.7}$$

This is an extraordinary equation. We have introduced it as the definition of temperature. But why is this a good definition? Why does it agree with the idea of temperature that your mum has? Why is this the same  $T$  that makes mercury rise (the element, not the planet...that’s a different course). Why is it the same  $T$  that makes us yell when we place our hand on a hot stove?

First, note that  $T$  has the right units, courtesy of Boltzmann’s constant (1.3). But that was our merely a choice of convention: it doesn’t explain why  $T$  has the properties that we expect of temperature. To make progress, we need to think more carefully about the kind of properties that we do expect. We will describe this in some detail in Section 4. For now it will suffice to describe the key property of temperature, which is the following: suppose we take two systems, each in equilibrium and each at the same temperature  $T$ , and place them in contact so that they can exchange energy. Then...nothing happens.

It is simple to see that this follows from our definition (1.7). We have already done the hard work above where we saw that two systems, brought into contact in this way,

will maximize their entropy. This is achieved when the first system has energy  $E_*$  and the second energy  $E_{\text{total}} - E_*$ , with  $E_*$  determined by equation (1.6). If we want nothing noticeable to happen when the systems are brought together, then it must have been the case that the energy of the first system was already at  $E_1 = E_*$ . Or, in other words, that equation (1.6) was obeyed before the systems were brought together,

$$\frac{\partial S_1(E_1)}{\partial E} = \frac{\partial S_2(E_2)}{\partial E} \quad (1.8)$$

From our definition (1.7), this is the same as requiring that the initial temperatures of the two systems are equal:  $T_1 = T_2$ .

Suppose now that we bring together two systems at slightly different temperatures. They will exchange energy, but conservation ensures that what the first system gives up, the second system receives and vice versa. So  $\delta E_1 = -\delta E_2$ . If the change of entropy is small, it is well approximated by

$$\begin{aligned} \delta S &= \frac{\partial S_1(E_1)}{\partial E} \delta E_1 + \frac{\partial S_2(E_2)}{\partial E} \delta E_2 \\ &= \left( \frac{\partial S_1(E_1)}{\partial E} - \frac{\partial S_2(E_2)}{\partial E} \right) \delta E_1 \\ &= \left( \frac{1}{T_1} - \frac{1}{T_2} \right) \delta E_1 \end{aligned}$$

The second law tells us that entropy must increase:  $\delta S > 0$ . This means that if  $T_1 > T_2$ , we must have  $\delta E_1 < 0$ . In other words, the energy flows in the way we would expect: from the hotter system to colder.

To summarise: the equilibrium argument tell us that  $\partial S/\partial E$  should have the interpretation as *some* function of temperature; the heat flowing argument tell us that it should be a monotonically decreasing function. But why  $1/T$  and not, say,  $1/T^2$ ? To see this, we really need to compute  $T$  for a system that we're all familiar with and see that it gives the right answer. Once we've got the right answer for one system, the equilibrium argument will ensure that it is right for all systems. Our first business in Section 2 will be to compute the temperature  $T$  for an ideal gas and confirm that (1.7) is indeed the correct definition.

## Heat Capacity

The heat capacity,  $C$ , is defined by

$$C = \frac{\partial E}{\partial T} \quad (1.9)$$

We will later introduce more refined versions of the heat capacity (in which various, yet-to-be-specified, external parameters are held constant or allowed to vary and we are more careful about the mode of energy transfer into the system). The importance of the heat capacity is that it is defined in terms of things that we can actually measure! Although the key theoretical concept is entropy, if you're handed an experimental system involving  $10^{23}$  particles, you can't measure the entropy directly by counting the number of accessible microstates. You'd be there all day. But you can measure the heat capacity: you add a known quantity of energy to the system and measure the rise in temperature. The result is  $C^{-1}$ .

There is another expression for the heat capacity that is useful. The entropy is a function of energy,  $S = S(E)$ . But we could invert the formula (1.7) to think of energy as a function of temperature,  $E = E(T)$ . We then have the expression

$$\frac{\partial S}{\partial T} = \frac{\partial S}{\partial E} \cdot \frac{\partial E}{\partial T} = \frac{C}{T}$$

This is a handy formula. If we can measure the heat capacity of the system for various temperatures, we can get a handle on the function  $C(T)$ . From this we can then determine the entropy of the system. Or, more precisely, the entropy difference

$$\Delta S = \int_{T_1}^{T_2} \frac{C(T)}{T} dT \quad (1.10)$$

Thus the heat capacity is our closest link between experiment and theory.

The heat capacity is always proportional to  $N$ , the number of particles in the system. It is common to define the *specific heat capacity*, which is simply the heat capacity divided by the mass of the system and is independent of  $N$ .

There is one last point to make about heat capacity. Differentiating (1.7) once more, we have

$$\frac{\partial^2 S}{\partial E^2} = -\frac{1}{T^2 C} \quad (1.11)$$

Nearly all systems you will meet have  $C > 0$ . (There is one important exception: a black hole has negative heat capacity!). Whenever  $C > 0$ , the system is said to be *thermodynamically stable*. The reason for this language goes back to the previous discussion concerning two systems which can exchange energy. There we wanted to maximize the entropy and checked that we had a stationary point (1.6), but we forgot to check whether this was a maximum or minimum. It is guaranteed to be a maximum if the heat capacity of both systems is positive so that  $\partial^2 S / \partial E^2 < 0$ .



### 1.2.3 An Example: The Two State System

Consider a system of  $N$  non-interacting particles. Each particle is fixed in position and can sit in one of two possible states which, for convenience, we will call “spin up”  $|\uparrow\rangle$  and “spin down”  $|\downarrow\rangle$ . We take the energy of these states to be,

$$E_{\downarrow} = 0 \quad , \quad E_{\uparrow} = \epsilon$$

which means that the spins want to be down; you pay an energy cost of  $\epsilon$  for each spin which points up. If the system has  $N_{\uparrow}$  particles with spin up and  $N_{\downarrow} = N - N_{\uparrow}$  particles with spin down, the energy of the system is

$$E = N_{\uparrow}\epsilon$$

We can now easily count the number of states  $\Omega(E)$  of the total system which have energy  $E$ . It is simply the number of ways to pick  $N_{\uparrow}$  particles from a total of  $N$ ,

$$\Omega(E) = \frac{N!}{N_{\uparrow}!(N - N_{\uparrow})!}$$

and the entropy is given by

$$S(E) = k_B \log \left( \frac{N!}{N_{\uparrow}!(N - N_{\uparrow})!} \right)$$

#### An Aside: Stirling’s Formula

For large  $N$ , there is a remarkably accurate approximation to the factorials that appear in the expression for the entropy. It is known as Stirling’s formula,

$$\log N! = N \log N - N + \frac{1}{2} \log 2\pi N + \mathcal{O}(1/N)$$

You will prove this on the first problem sheet. However, for our purposes we will only need the first two terms in this expansion and these can be very quickly derived by looking at the expression

$$\log N! = \sum_{p=1}^N \log p \approx \int_1^N dp \log p = N \log N - N + 1$$

where we have approximated the sum by the integral as shown in the figure. You can also see from the figure that integral gives a lower bound on the sum which is confirmed by checking the next terms in Stirling’s formula.

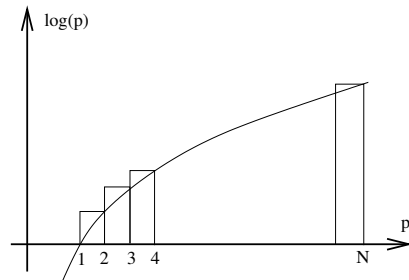

**Figure 2:**

## Back to the Physics

Using Stirling's approximation, we can write the entropy as

$$\begin{aligned}
 S(E) &= k_B [N \log N - N - N_\uparrow \log N_\uparrow + N_\uparrow - (N - N_\uparrow) \log(N - N_\uparrow) + (N - N_\uparrow)] \\
 &= -k_B \left[ (N - N_\uparrow) \log \left( \frac{N - N_\uparrow}{N} \right) + N_\uparrow \log \left( \frac{N_\uparrow}{N} \right) \right] \\
 &= -k_B N \left[ \left( 1 - \frac{E}{N\epsilon} \right) \log \left( 1 - \frac{E}{N\epsilon} \right) + \frac{E}{N\epsilon} \log \left( \frac{E}{N\epsilon} \right) \right]
 \end{aligned} \tag{1.12}$$

A sketch of  $S(E)$  plotted against  $E$  is shown in Figure 3. The entropy vanishes when  $E = 0$  (all spins down) and  $E = N\epsilon$  (all spins up) because there is only one possible state with each of these energies. The entropy is maximal when  $E = N\epsilon/2$  where we have  $S = Nk_B \log 2$ .

If the system has energy  $E$ , its temperature is

$$\frac{1}{T} = \frac{\partial S}{\partial E} = \frac{k_B}{\epsilon} \log \left( \frac{N\epsilon}{E} - 1 \right)$$

We can also invert this expression. If the system has temperature  $T$ , the fraction of particles with spin up is given by

$$\frac{N_\uparrow}{N} = \frac{E}{N\epsilon} = \frac{1}{e^{\epsilon/k_B T} + 1} \tag{1.13}$$

Note that as  $T \rightarrow \infty$ , the fraction of spins  $N_\uparrow/N \rightarrow 1/2$ . In the limit of infinite temperature, the system sits at the peak of the curve in Figure 3.

What happens for energies  $E > N\epsilon/2$ , where  $N_\uparrow/N > 1/2$ ? From the definition of temperature as  $1/T = \partial S/\partial E$ , it is clear that we have entered the realm of *negative temperatures*. This should be thought of as hotter than infinity! (This is simple to see in the variables  $1/T$  which tends towards zero and then just keeps going to negative values). Systems with negative temperatures have the property that the number of microstates decreases as we add energy. They can be realised in laboratories, at least temporarily, by instantaneously flipping all the spins in a system.

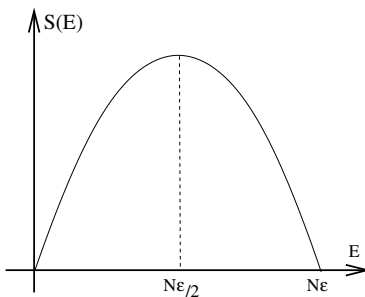

**Figure 3:** Entropy of the two-state system

## Heat Capacity and the Schottky Anomaly

Finally, we can compute the heat capacity, which we choose to express as a function of temperature (rather than energy) since this is more natural when comparing to experiment. We then have

$$C = \frac{dE}{dT} = \frac{N\epsilon^2}{k_B T^2} \frac{e^{\epsilon/k_B T}}{(e^{\epsilon/k_B T} + 1)^2} \quad (1.14)$$

Note that  $C$  is of order  $N$ , the number of particles in the system. This property extends to all other examples that we will study. A sketch of  $C$  vs  $T$  is shown in Figure 4. It starts at zero, rises to a maximum, then drops off again. We'll see a lot of graphs in this course that look more or less like this. Let's look at some of the key features in this case. Firstly, the maximum is around  $T \sim \epsilon/k_B$ . In other words, the maximum point sits at the characteristic energy scale in the system.

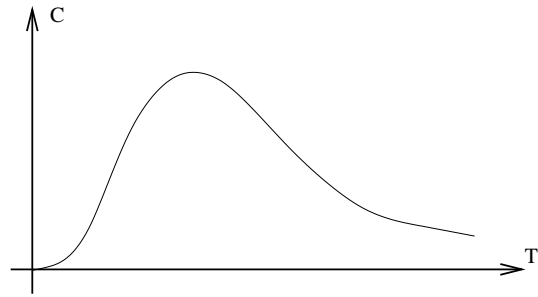

**Figure 4:** Heat Capacity of the two state system

As  $T \rightarrow 0$ , the specific heat drops to zero exponentially quickly. (Recall that  $e^{-1/x}$  is a function which tends towards zero faster than any power  $x^n$ ). The reason for this fast fall-off can be traced back to the existence of an *energy gap*, meaning that the first excited state is a finite energy above the ground state. The heat capacity also drops off as  $T \rightarrow \infty$ , but now at a much slower power-law pace. This fall-off is due to the fact that all the states are now occupied.

The contribution to the heat capacity from spins is not the dominant contribution in most materials. It is usually dwarfed by the contribution from phonons and, in metals, from conduction electrons, both of which we will calculate later in the course. Nonetheless, in certain classes of material — for example, paramagnetic salts — a spin contribution of the form (1.14) can be seen at low temperatures where it appears as a small bump in the graph and is referred to as the *Schottky anomaly*. (It is “anomalous” because most materials have a heat capacity which decreases monotonically as temperature is reduced). In Figure 5, the Schottky contribution has been isolated from the phonon

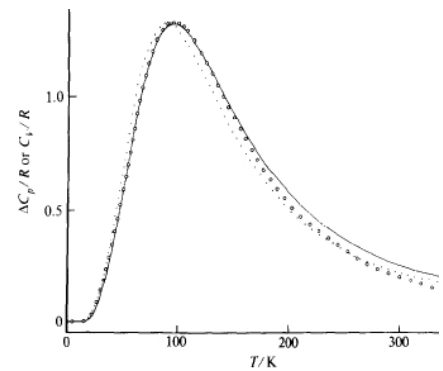

**Figure 5:**

contribution<sup>1</sup>. The open circles and dots are both data (interpreted in mildly different ways); the solid line is theoretical prediction, albeit complicated slightly by the presence of a number of spin states. The deviations are most likely due to interactions between the spins.

The two state system can also be used as a model for defects in a lattice. In this case, the “spin down” state corresponds to an atom sitting in the lattice where it should be with no energy cost. The “spin up” state now corresponds to a missing atom, ejected from its position at energy cost  $\epsilon$ .

### 1.2.4 Pressure, Volume and the First Law of Thermodynamics

We will now start to consider other external parameters which can affect different systems. We will see a few of these as we move through the course, but the most important one is perhaps the most obvious – the volume  $V$  of a system. This didn’t play a role in the two-state example because the particles were fixed. But as soon as objects are free to move about, it becomes crucial to understand how far they can roam.

We’ll still use the same notation for the number of states and entropy of the system, but now these quantities will be functions of both the energy and the volume,

$$S(E, V) = k_B \log \Omega(E, V)$$

The temperature is again given by  $1/T = \partial S / \partial E$ , where the partial derivative implicitly means that we keep  $V$  fixed when we differentiate. But now there is a new, natural quantity that we can consider — the differentiation with respect to  $V$ . This also gives a quantity that you’re all familiar with — *pressure*,  $p$ . Well, almost. The definition is

$$p = T \frac{\partial S}{\partial V} \tag{1.15}$$

To see that this is a sensible definition, we can replay the arguments of Section 1.2.2. Imagine two systems in contact through a moveable partition as shown in the figure above, so that the total volume remains fixed, but system 1 can expand at the expense of system 2 shrinking. The same equilibrium arguments that previously lead to (1.8) now tell us that the volumes of the systems don’t change as long as  $\partial S / \partial V$  is the same for both systems. Or, in other words, as long as the pressures are equal.

Despite appearances, the definition of pressure actually has little to do with entropy. Roughly speaking, the  $S$  in the derivative cancels the factor of  $S$  sitting in  $T$ . To make

---

<sup>1</sup>The data is taken from Chirico and Westrum Jr., J. Chem. Thermodynamics 12 (1980), 311, and shows the spin contribution to the heat capacity of  $\text{Tb}(\text{OH})_3$

this mathematically precise, consider a system with entropy  $S(E, V)$  that undergoes a small change in energy and volume. The change in entropy is

$$dS = \frac{\partial S}{\partial E} dE + \frac{\partial S}{\partial V} dV$$

Rearranging, and using our definitions (1.7) and (1.15), we can write

$$dE = TdS - pdV \tag{1.16}$$

The left-hand side is the change in energy of the system. It is easy to interpret the second term on the right-hand side: it is the work done on the system. To see this, consider the diagram on the right. Recall that pressure is force per area. The change of volume in the set-up depicted is  $dV = \text{Area} \times dx$ . So the work done on the system is  $\text{Force} \times dx = (pA)dx = pdV$ . To make sure that we've got the minus signs right, remember that if  $dV < 0$ , we're exerting a force to squeeze the system, increasing its energy. In contrast, if  $dV > 0$ , the system itself is doing the work and hence losing energy.

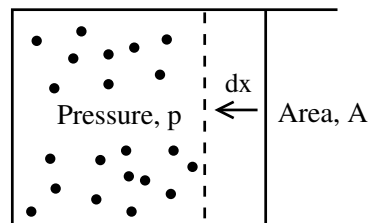

**Figure 7:** Work Done

Alternatively, you may prefer to run this argument in reverse: if you're happy to equate squeezing the system by  $dV$  with doing work, then the discussion above is sufficient to tell you that pressure as defined in (1.15) has the interpretation of force per area.

What is the interpretation of the first term on the right-hand side of (1.16)? It must be some form of energy transferred to the system. It turns out that the correct interpretation of  $TdS$  is the amount of *heat* the system absorbs from the surroundings. Much of Section 4 will be concerned with understanding why this is right way to think about  $TdS$  and we postpone a full discussion until then.

Equation (1.16) expresses the conservation of energy for a system at finite temperature. It is known as the *First Law of Thermodynamics*. (You may have noticed that we're not doing these laws in order! This too will be rectified in Section 4).

As a final comment, we can now give a slightly more refined definition of the heat capacity (1.9). In fact, there are several different heat capacities which depend on which other variables are kept fixed. Throughout most of these lectures, we will be interested in the heat capacity at fixed volume, denoted  $C_V$ ,

$$C_V = \left. \frac{\partial E}{\partial T} \right|_V \tag{1.17}$$

Using the first law of thermodynamics (1.16), we see that something special happens when we keep volume constant: the work done term drops out and we have

$$C_V = T \left. \frac{\partial S}{\partial T} \right|_V \quad (1.18)$$

This form emphasises that, as its name suggests, the heat capacity measures the ability of the system to absorb *heat*  $TdS$  as opposed to any other form of energy. (Although, admittedly, we still haven't really defined what heat is. As mentioned above, this will have to wait until Section 4).

The equivalence of (1.17) and (1.18) only followed because we kept volume fixed. What is the heat capacity if we keep some other quantity, say pressure, fixed? In this case, the correct definition of heat capacity is the expression analogous to (1.18). So, for example, the heat capacity at constant pressure  $C_p$  is defined by

$$C_p = T \left. \frac{\partial S}{\partial T} \right|_p$$

For the next few Sections, we'll only deal with  $C_V$ . But we'll return briefly to the relationship between  $C_V$  and  $C_p$  in Section 4.4.

### 1.2.5 Ludwig Boltzmann (1844-1906)

“My memory for figures, otherwise tolerably accurate, always lets me down when I am counting beer glasses”

#### *Boltzmann Counting*

Ludwig Boltzmann was born into a world that doubted the existence of atoms<sup>2</sup>. The cumulative effect of his lifetime's work was to change this. No one in the 1800s ever thought we could see atoms directly and Boltzmann's strategy was to find indirect, yet overwhelming, evidence for their existence. He developed much of the statistical machinery that we have described above and, building on the work of Maxwell, showed that many of the seemingly fundamental laws of Nature — those involving heat and gases in particular — were simply consequences of Newton's laws of motion when applied to very large systems.

---

<sup>2</sup>If you want to learn more about his life, I recommend the very enjoyable biography, *Boltzmann's Atom* by David Lindley. The quote above is taken from a travel essay that Boltzmann wrote recounting a visit to California. The essay is reprinted in a drier, more technical, biography by Carlo Cercignani.

It is often said that Boltzmann's great insight was the equation which is now engraved on his tombstone,  $S = k_B \log \Omega$ , which led to the understanding of the second law of thermodynamics in terms of microscopic disorder. Yet these days it is difficult to appreciate the boldness of this proposal simply because we rarely think of any other definition of entropy. We will, in fact, meet the older thermodynamic notion of entropy and the second law in Section 4 of this course. In the meantime, perhaps Boltzmann's genius is better reflected in the surprising equation for temperature:  $1/T = \partial S / \partial E$ .

Boltzmann gained prominence during his lifetime, holding professorships at Graz, Vienna, Munich and Leipzig (not to mention a position in Berlin that he somehow failed to turn up for). Nonetheless, his work faced much criticism from those who would deny the existence of atoms, most notably Mach. It is not known whether these battles contributed to the depression Boltzmann suffered later in life, but the true significance of his work was only appreciated after his body was found hanging from the rafters of a guest house near Trieste.

### 1.3 The Canonical Ensemble

The microcanonical ensemble describes systems that have a fixed energy  $E$ . From this, we deduce the equilibrium temperature  $T$ . However, very often this is not the best way to think about a system. For example, a glass of water sitting on a table has a well defined average energy. But the energy is constantly fluctuating as it interacts with the environment. For such systems, it is often more appropriate to think of them as sitting at fixed temperature  $T$ , from which we then deduce the average energy.

To model this, we will consider a system — let's call it  $S$  — in contact with a second system which is a large *heat reservoir* — let's call it  $R$ . This reservoir is taken to be at some equilibrium temperature  $T$ . The term “reservoir” means that the energy of  $S$  is negligible compared with that of  $R$ . In particular,  $S$  can happily absorb or donate energy from or to the reservoir without changing the ambient temperature  $T$ .

How are the energy levels of  $S$  populated in such a situation? We label the states of  $S$  as  $|n\rangle$ , each of which has energy  $E_n$ . The number of microstates of the combined systems  $S$  and  $R$  is given by the sum over all states of  $S$ ,

$$\Omega(E_{\text{total}}) = \sum_n \Omega_R(E_{\text{total}} - E_n) \equiv \sum_n \exp\left(\frac{S_R(E_{\text{total}} - E_n)}{k_B}\right)$$

I stress again that the sum above is over all the states of  $S$ , rather than over the energy levels of  $S$ . (If we'd written the latter, we would have to include a factor of  $\Omega_S(E_n)$  in the sum to take into account the degeneracy of states with energy  $E_n$ ). The fact that

$R$  is a reservoir means that  $E_n \ll E_{\text{total}}$ . This allows us to Taylor expand the entropy, keeping just the first two terms,

$$\Omega(E_{\text{total}}) \approx \sum_n \exp\left(\frac{S_R(E_{\text{total}})}{k_B} - \frac{\partial S_R}{\partial E_{\text{total}}} \frac{E_n}{k_B}\right)$$

But we know that  $\partial S_R/\partial E_{\text{total}} = 1/T$ , so we have

$$\Omega(E_{\text{total}}) = e^{S_R(E_{\text{total}})/k_B} \sum_n e^{-E_n/k_B T}$$

We now apply the fundamental assumption of statistical mechanics — that all accessible energy states are equally likely — to the combined system + reservoir. This means that each of the  $\Omega(E_{\text{total}})$  states above is equally likely. The number of these states for which the system sits in  $|n\rangle$  is  $e^{S_R/k_B} e^{-E_n/k_B T}$ . So the probability that the system sits in state  $|n\rangle$  is just the ratio of this number of states to the total number of states,

$$p(n) = \frac{e^{-E_n/k_B T}}{\sum_m e^{-E_m/k_B T}} \quad (1.19)$$

This is the *Boltzmann distribution*, also known as the *canonical ensemble*. Notice that the details of the reservoir have dropped out. We don't need to know  $S_R(E)$  for the reservoir; all that remains of its influence is the temperature  $T$ .

The exponential suppression in the Boltzmann distribution means that it is very unlikely that any of the states with  $E_n \gg k_B T$  are populated. However, all states with energy  $E_n \leq k_B T$  have a decent chance of being occupied. Note that as  $T \rightarrow 0$ , the Boltzmann distribution forces the system into its ground state (i.e. the state with lowest energy); all higher energy states have vanishing probability at zero temperature.

### 1.3.1 The Partition Function

Since we will be using various quantities a lot, it is standard practice to introduce new notation. Firstly, the inverse factor of the temperature is universally denoted,

$$\beta \equiv \frac{1}{k_B T} \quad (1.20)$$

And the normalization factor that sits in the denominator of the probability is written,

$$Z = \sum_n e^{-\beta E_n} \quad (1.21)$$

In this notation, the probability for the system to be found in state  $|n\rangle$  is

$$p(n) = \frac{e^{-\beta E_n}}{Z} \quad (1.22)$$



Rather remarkably, it turns out that the most important quantity in statistical mechanics is  $Z$ . Although this was introduced as a fairly innocuous normalization factor, it actually contains all the information we need about the system. We should think of  $Z$ , as defined in (1.21), as a function of the (inverse) temperature  $\beta$ . When viewed in this way,  $Z$  is called the *partition function*.

We'll see lots of properties of  $Z$  soon. But we'll start with a fairly basic, yet important, point: for independent systems,  $Z$ 's multiply. This is easy to prove. Suppose that we have two systems which don't interact with each other. The energy of the combined system is then just the sum of the individual energies. The partition function for the combined system is (in, hopefully, obvious notation)

$$\begin{aligned} Z &= \sum_{n,m} e^{-\beta(E_n^{(1)} + E_m^{(2)})} \\ &= \sum_{n,m} e^{-\beta E_n^{(1)}} e^{-\beta E_m^{(2)}} \\ &= \sum_n e^{-\beta E_n^{(1)}} \sum_m e^{-\beta E_m^{(2)}} = Z_1 Z_2 \end{aligned} \tag{1.23}$$

## A Density Matrix for the Canonical Ensemble

In statistical mechanics, the inherent probabilities of the quantum world are joined with probabilities that arise from our ignorance of the underlying state. The correct way to describe this is in terms of a density matrix,  $\hat{\rho}$ . The canonical ensemble is really a choice of density matrix,

$$\hat{\rho} = \frac{e^{-\beta \hat{H}}}{Z} \tag{1.24}$$

If we make a measurement described by an operator  $\hat{O}$ , then the probability that we find ourselves in the eigenstate  $|\phi\rangle$  is given by

$$p(\phi) = \langle \phi | \hat{\rho} | \phi \rangle$$

For energy eigenstates, this coincides with our earlier result (1.22). We won't use the language of density matrices in this course, but it is an elegant and conceptually clear framework to describe more formal results.

### 1.3.2 Energy and Fluctuations

Let's see what information is contained in the partition function. We'll start by thinking about the energy. In the microcanonical ensemble, the energy was fixed. In the

canonical ensemble, that is no longer true. However, we can happily compute the average energy,

$$\langle E \rangle = \sum_n p(n) E_n = \sum_n \frac{E_n e^{-\beta E_n}}{Z}$$

But this can be very nicely expressed in terms of the partition function by

$$\langle E \rangle = -\frac{\partial}{\partial \beta} \log Z \quad (1.25)$$

We can also look at the spread of energies about the mean — in other words, about fluctuations in the probability distribution. As usual, this spread is captured by the variance,

$$\Delta E^2 = \langle (E - \langle E \rangle)^2 \rangle = \langle E^2 \rangle - \langle E \rangle^2$$

This too can be written neatly in terms of the partition function,

$$\Delta E^2 = \frac{\partial^2}{\partial \beta^2} \log Z = -\frac{\partial \langle E \rangle}{\partial \beta} \quad (1.26)$$

There is another expression for the fluctuations that provides some insight. Recall our definition of the heat capacity (1.9) in the microcanonical ensemble. In the canonical ensemble, where the energy is not fixed, the corresponding definition is

$$C_V = \left. \frac{\partial \langle E \rangle}{\partial T} \right|_V$$

Then, since  $\beta = 1/k_B T$ , the spread of energies in (1.26) can be expressed in terms of the heat capacity as

$$\Delta E^2 = k_B T^2 C_V \quad (1.27)$$

There are two important points hiding inside this small equation. The first is that the equation relates two rather different quantities. On the left-hand side,  $\Delta E$  describes the probabilistic fluctuations in the energy of the system. On the right-hand side, the heat capacity  $C_V$  describes the ability of the system to absorb energy. If  $C_V$  is large, the system can take in a lot of energy without raising its temperature too much. The equation (1.27) tells us that the fluctuations of the systems are related to the ability of the system to dissipate, or absorb, energy. This is the first example of a more general result known as the *fluctuation-dissipation theorem*.

The other point to take away from (1.27) is the size of the fluctuations as the number of particles  $N$  in the system increases. Typically  $E \sim N$  and  $C_V \sim N$ . Which means that the relative size of the fluctuations scales as

$$\frac{\Delta E}{E} \sim \frac{1}{\sqrt{N}} \quad (1.28)$$

The limit  $N \rightarrow \infty$  is known as the *thermodynamic limit*. The energy becomes peaked closer and closer to the mean value  $\langle E \rangle$  and can be treated as essentially fixed. But this was our starting point for the microcanonical ensemble. In the thermodynamic limit, the microcanonical and canonical ensembles coincide.

All the examples that we will discuss in the course will have a *very* large number of particles,  $N$ , and we can consider ourselves safely in the thermodynamic limit. For that reason, even in the canonical ensemble, we will often write  $E$  for the average energy rather than  $\langle E \rangle$ .

### An Example: The Two State System Revisited

We can rederive our previous results for the two state system using the canonical ensemble. It is marginally simpler. For a single particle with two energy levels, 0 and  $\epsilon$ , the partition function is given by

$$Z_1 = \sum_n e^{-\beta E_n} = 1 + e^{-\beta \epsilon} = 2e^{-\beta \epsilon/2} \cosh(\beta \epsilon/2)$$

We want the partition function for  $N$  such particles. But we saw in (1.23) that if we have independent systems, then we simply need to multiply their partition functions together. We then have

$$Z = 2^N e^{-N\beta \epsilon/2} \cosh^N(\beta \epsilon/2)$$

from which we can easily compute the average energy

$$\langle E \rangle = -\frac{\partial}{\partial \beta} \log Z = \frac{N\epsilon}{2} (1 - \tanh(\beta \epsilon/2))$$

A bit of algebra will reveal that this is the same expression that we derived in the microcanonical ensemble (1.13). We could now go on to compute the heat capacity and reproduce the result (1.14).

Notice that, unlike in the microcanonical ensemble, we didn't have to solve any combinatoric problem to count states. The partition function has done all that work for us. Of course, for this simple two state system, the counting of states wasn't difficult but in later examples, where the counting gets somewhat trickier, the partition function will be an invaluable tool to save us the work.

### 1.3.3 Entropy

Recall that in the microcanonical ensemble, the entropy counts the (log of the) number of states with fixed energy. We would like to define an analogous quantity in the canonical ensemble where we have a probability distribution over states with different energies. How to proceed? Our strategy will be to again return to the microcanonical ensemble, now applied to the combined system + reservoir.

In fact, we're going to use a little trick. Suppose that we don't have just one copy of our system  $S$ , but instead a large number,  $W$ , of identical copies. Each system lives in a particular state  $|n\rangle$ . If  $W$  is large enough, the number of systems that sit in state  $|n\rangle$  must be simply  $p(n)W$ . We see that the trick of taking  $W$  copies has translated the probabilities into eventualities. To determine the entropy we can treat the whole collection of  $W$  systems as sitting in the microcanonical ensemble to which we can apply the familiar Boltzmann definition of entropy (1.2). We must only figure out how many ways there are of putting  $p(n)W$  systems into state  $|n\rangle$  for each  $|n\rangle$ . That's a simple combinatoric problem: the answer is

$$\Omega = \frac{W!}{\prod_n (p(n)W)!}$$

And the entropy is therefore

$$S = k_B \log \Omega = -k_B W \sum_n p(n) \log p(n) \quad (1.29)$$

where we have used Stirling's formula to simplify the logarithms of factorials. This is the entropy for all  $W$  copies of the system. But we also know that entropy is additive. So the entropy for a single copy of the system, with probability distribution  $p(n)$  over the states is

$$S = -k_B \sum_n p(n) \log p(n) \quad (1.30)$$

This beautiful formula is due to Gibbs. It was rediscovered some decades later in the context of information theory where it goes by the name of Shannon entropy for classical systems or von Neumann entropy for quantum systems. In the quantum context, it is sometimes written in terms of the density matrix (1.24) as

$$S = -k_B \text{Tr } \hat{\rho} \log \hat{\rho}$$

When we first introduced entropy in the microcanonical ensemble, we viewed it as a function of the energy  $E$ . But (1.30) gives a very different viewpoint on the entropy:

it says that we should view  $S$  as a function of a probability distribution. There is no contradiction with the microcanonical ensemble because in that simple case, the probability distribution is itself determined by the choice of energy  $E$ . Indeed, it is simple to check (and you should!) that the Gibbs entropy (1.30) reverts to the Boltzmann entropy in the special case of  $p(n) = 1/\Omega(E)$  for all states  $|n\rangle$  of energy  $E$ .

Meanwhile, back in the canonical ensemble, the probability distribution is entirely determined by the choice of temperature  $T$ . This means that the entropy is naturally a function of  $T$ . Indeed, substituting the Boltzmann distribution  $p(n) = e^{-\beta E_n}/Z$  into the expression (1.30), we find that the entropy in the canonical ensemble is given by

$$\begin{aligned} S &= -\frac{k_B}{Z} \sum_n e^{-\beta E_n} \log \left( \frac{e^{-\beta E_n}}{Z} \right) \\ &= \frac{k_B \beta}{Z} \sum_n E_n e^{-\beta E_n} + k_B \log Z \end{aligned}$$

As with all other important quantities, this can be elegantly expressed in terms of the partition function by

$$S = k_B \frac{\partial}{\partial T} (T \log Z) \quad (1.31)$$

### A Comment on the Microcanonical vs Canonical Ensembles

The microcanonical and canonical ensembles are different probability distributions. This means, using the definition (1.30), that they generally have different entropies. Nonetheless, in the limit of a large number of particles,  $N \rightarrow \infty$ , all physical observables — including entropy — coincide in these two distributions. We've already seen this when we computed the variance of energy (1.28) in the canonical ensemble. Let's take a closer look at how this works.

The partition function in (1.21) is a sum over all states. We can rewrite it as a sum over energy levels by including a degeneracy factor

$$Z = \sum_{\{E_i\}} \Omega(E_i) e^{-\beta E_i}$$

The degeneracy factor  $\Omega(E)$  factor is typically a rapidly rising function of  $E$ , while the Boltzmann suppression  $e^{-\beta E}$  is rapidly falling. But, for both the exponent is proportional to  $N$  which is itself exponentially large. This ensures that the sum over energy levels is entirely dominated by the maximum value,  $E_*$ , defined by the requirement

$$\frac{\partial}{\partial E} \left( \Omega(E) e^{-\beta E} \right)_{E=E_*} = 0$$

and the partition function can be well approximated by

$$Z \approx \Omega(E_\star) e^{-\beta E_\star}$$

(This is the same kind of argument we used in (1.2.1) in our discussion of the Second Law). With this approximation, we can use (1.25) to show that the most likely energy  $E_\star$  and the average energy  $\langle E \rangle$  coincide:

$$\langle E \rangle = E_\star$$

(We need to use the result (1.7) in the form  $\partial \log \Omega(E_\star) / \partial E_\star = \beta$  to derive this). Similarly, using (1.31), we can show that the entropy in the canonical ensemble is given by

$$S = k_B \log \Omega(E_\star)$$

## Maximizing Entropy

There is actually a unified way to think about the microcanonical and canonical ensembles in terms of a variational principle: the different ensembles have the property that they maximise the entropy subject to various constraints. The only difference between them is the constraints that are imposed.

Let's start with the microcanonical ensemble, in which we fix the energy of the system so that we only allow non-zero probabilities for those states which have energy  $E$ . We could then compute the entropy using the Gibbs formula (1.30) for any probability distribution, including systems away from equilibrium. We need only insist that all the probabilities add up to one:  $\sum_n p(n) = 1$ . We can maximise  $S$  subject to this condition by introducing a Lagrange multiplier  $\alpha$  and maximising  $S + \alpha k_B (\sum_n p(n) - 1)$ ,

$$\frac{\partial}{\partial p(n)} \left( - \sum_n p(n) \log p(n) + \alpha \sum_n p(n) - \alpha \right) = 0 \quad \Rightarrow \quad p(n) = e^{\alpha-1}$$

We learn that all states with energy  $E$  are equally likely. This is the microcanonical ensemble.

In the examples sheet, you will be asked to show that the canonical ensemble can be viewed in the same way: it is the probability distribution that maximises the entropy subject to the constraint that the *average* energy is fixed.

### 1.3.4 Free Energy

We've left the most important quantity in the canonical ensemble to last. It is called the *free energy*,

$$F = \langle E \rangle - TS \quad (1.32)$$

There are actually a number of quantities all vying for the name “free energy”, but the quantity  $F$  is the one that physicists usually work with. When necessary to clarify, it is sometimes referred to as the Helmholtz free energy. The word “free” here doesn't mean “without cost”. Energy is never free in that sense. Rather, it should be interpreted as the “available” energy.

Heuristically, the free energy captures the competition between energy and entropy that occurs in a system at constant temperature. Immersed in a heat bath, energy is not necessarily at a premium. Indeed, we saw in the two-state example that the ground state plays little role in the physics at non-zero temperature. Instead, the role of entropy becomes more important: the existence of many high energy states can beat a few low-energy ones.

The fact that the free energy is the appropriate quantity to look at for systems at fixed temperature is also captured by its mathematical properties. Recall, that we started in the microcanonical ensemble by defining entropy  $S = S(E, V)$ . If we invert this expression, then we can equally well think of energy as a function of entropy and volume:  $E = E(S, V)$ . This is reflected in the first law of thermodynamics (1.16) which reads  $dE = TdS - pdV$ . However, if we look at small variations in  $F$ , we get

$$dF = d\langle E \rangle - d(TS) = -SdT - pdV \quad (1.33)$$

This form of the variation is telling us that we should think of the free energy as a function of temperature and volume:  $F = F(T, V)$ . Mathematically,  $F$  is a Legendre transform of  $E$ .

Given the free energy, the variation (1.33) tells us how to get back the entropy,

$$S = - \left. \frac{\partial F}{\partial T} \right|_V \quad (1.34)$$

Similarly, the pressure is given by

$$p = - \left. \frac{\partial F}{\partial V} \right|_T \quad (1.35)$$

The free energy is the most important quantity at fixed temperature. It is also the quantity that is most directly related to the partition function  $Z$ :

$$F = -k_B T \log Z \quad (1.36)$$

This relationship follows from (1.25) and (1.31). Using the identity  $\partial/\partial\beta = -k_B T^2 \partial/\partial T$ , these expressions allow us to write the free energy as

$$\begin{aligned} F = E - TS &= k_B T^2 \frac{\partial}{\partial T} \log Z - k_B T \frac{\partial}{\partial T} (T \log Z) \\ &= -k_B T \log Z \end{aligned}$$

as promised.

## 1.4 The Chemical Potential

Before we move onto applications, there is one last bit of formalism that we will need to introduce. This arises in situations where there is some other conserved quantity which restricts the states that are accessible to the system. The most common example is simply the number of particles  $N$  in the system. Another example is the electric charge  $Q$ . For the sake of definiteness, we will talk about particle number below but all the comments apply to any conserved quantity.

In both the microcanonical and canonical ensembles, we should only consider states that have a fixed value of  $N$ . We already did this when we discussed the two state system — for example, the expression for entropy (1.12) depends explicitly on the number of particles  $N$ . We will now make this dependence explicit and write

$$S(E, V, N) = k_B \log \Omega(E, V, N)$$

The entropy leads us to the temperature as  $1/T = \partial S/\partial E$  and the pressure as  $p = T \partial S/\partial V$ . But now we have another option: we can differentiate with respect to particle number  $N$ . The resulting quantity is called the *chemical potential*,

$$\mu = -T \frac{\partial S}{\partial N} \quad (1.37)$$

Using this definition, we can re-run the arguments given in Section 1.2.2 for systems which are allowed to exchange particles. Such systems are in equilibrium only if they have equal chemical potential  $\mu$ . This condition is usually referred to as chemical equilibrium.



To get a feel for the meaning of the chemical potential, we can look again at the first law of thermodynamics (1.16), now allowing for a change in particle number as well. Writing  $dS = \dots$  and rearranging, we have,

$$dE = TdS - pdV + \mu dN \quad (1.38)$$

This tells us the meaning of the chemical potential: it is the energy cost to add one more particle to the system while keeping both  $S$  and  $V$  fixed. (Strictly speaking, an infinitesimal amount of particle, but if we're adding one more to  $10^{23}$  that effectively counts as infinitesimal). If we're interested in electric charge  $Q$ , rather than particle number, the chemical potential is the same thing as the familiar electrostatic potential of the system that you met in your first course in electromagnetism.

There's actually a subtle point in the above derivation that is worth making explicit. It's the kind of thing that will crop up a lot in thermodynamics where you typically have many variables and need to be careful about which ones are kept fixed. We defined the chemical potential as  $\mu = -T \partial S / \partial N|_{E,V}$ . But the first law is telling us that we can also think of the chemical potential as  $\mu = \partial E / \partial N|_{S,V}$ . Why is this the same thing? This follows from a general formula for partial derivatives. If you have three variables,  $x$ ,  $y$  and  $z$ , with a single constraint between them, then

$$\left. \frac{\partial x}{\partial y} \right|_z \left. \frac{\partial y}{\partial z} \right|_x \left. \frac{\partial z}{\partial x} \right|_y = -1$$

Applying this general formula to  $E$ ,  $S$  and  $N$  gives us the required result

$$\left. \frac{\partial E}{\partial N} \right|_{S,V} = - \left. \frac{\partial S}{\partial N} \right|_{E,v} \left. \frac{\partial E}{\partial S} \right|_{N,V} = \mu$$

If we work at constant temperature rather than constant energy, the relevant function is the free energy  $F(T, V, N) = E - TS$ . Small changes are given by

$$dF = -SdT - pdV + \mu dN$$

from which we see that the chemical potential can also be defined as

$$\mu = \left. \frac{\partial F}{\partial N} \right|_{T,V}$$

### 1.4.1 Grand Canonical Ensemble

When we made the transition from microcanonical to canonical ensemble, we were no longer so rigid in our insistence that the system has a fixed energy. Rather it could freely

exchange energy with the surrounding reservoir, which was kept at a fixed temperature. We could now imagine the same scenario with any other conserved quantity. For example, if particles are free to move between the system and the reservoir, then  $N$  is no longer fixed. In such a situation, we will require that the reservoir sits at fixed chemical potential  $\mu$  as well as fixed temperature  $T$ .

The probability distribution that we need to use in this case is called the *grand canonical ensemble*. The probability of finding the system in a state  $|n\rangle$  depends on both the energy  $E_n$  and the particle number  $N_n$ . (Notice that because  $N$  is conserved, the quantum mechanical operator necessarily commutes with the Hamiltonian so there is no difficulty in assigning both energy and particle number to each state). We introduce the *grand canonical partition function*

$$\mathcal{Z}(T, \mu, V) = \sum_n e^{-\beta(E_n - \mu N_n)} \quad (1.39)$$

Re-running the argument that we used for the canonical ensemble, we find the probability that the system is in state  $|n\rangle$  to be

$$p(n) = \frac{e^{-\beta(E_n - \mu N_n)}}{\mathcal{Z}}$$

In the canonical ensemble, all the information that we need is contained within the partition function  $Z$ . In the grand canonical ensemble it is contained within  $\mathcal{Z}$ . The entropy (1.30) is once again given by

$$S = k_B \frac{\partial}{\partial T} (T \log \mathcal{Z}) \quad (1.40)$$

while differentiating with respect to  $\beta$  gives us

$$\langle E \rangle - \mu \langle N \rangle = - \frac{\partial}{\partial \beta} \log \mathcal{Z} \quad (1.41)$$

The average particle number  $\langle N \rangle$  in the system can then be separately extracted by

$$\langle N \rangle = \frac{1}{\beta} \frac{\partial}{\partial \mu} \log \mathcal{Z} \quad (1.42)$$

and its fluctuations,

$$\Delta N^2 = \frac{1}{\beta^2} \frac{\partial^2}{\partial \mu^2} \log \mathcal{Z} = \frac{1}{\beta} \frac{\partial \langle N \rangle}{\partial \mu} \quad (1.43)$$

Just as the average energy is determined by the temperature in the canonical ensemble, here the average particle number is determined by the chemical potential. The grand canonical ensemble will simplify several calculations later, especially when we come to discuss Bose and Fermi gases in Section 3.

The relative size of these fluctuations scales in the same way as the energy fluctuations,  $\Delta N/\langle N \rangle \sim 1/\sqrt{\langle N \rangle}$ , and in the thermodynamic limit  $N \rightarrow \infty$  results from all three ensembles coincide. For this reason, we will drop the averaging brackets  $\langle \cdot \rangle$  from our notation and simply refer to the average particle number as  $N$ .

### 1.4.2 Grand Canonical Potential

The grand canonical potential  $\Phi$  is defined by

$$\Phi = F - \mu N$$

$\Phi$  is a Legendre transform of  $F$ , from variable  $N$  to  $\mu$ . This is underlined if we look at small variations,

$$d\Phi = -SdT - pdV - Nd\mu \tag{1.44}$$

which tells us that  $\Phi$  should be thought of as a function of temperature, volume and chemical potential,  $\Phi = \Phi(T, V, \mu)$ .

We can perform the same algebraic manipulations that gave us  $F$  in terms of the canonical partition function  $Z$ , this time using the definitions (1.40) and (1.41)) to write  $\Phi$  as

$$\Phi = -k_B T \log Z \tag{1.45}$$

### 1.4.3 Extensive and Intensive Quantities

There is one property of  $\Phi$  that is rather special and, at first glance, somewhat surprising. This property actually follows from very simple considerations of how different variables change as we look at bigger and bigger systems.

Suppose we have a system and we double it. That means that we double the volume  $V$ , double the number of particles  $N$  and double the energy  $E$ . What happens to all our other variables? We have already seen back in Section 1.2.1 that entropy is additive, so  $S$  also doubles. More generally, if we scale  $V$ ,  $N$  and  $E$  by some amount  $\lambda$ , the entropy must scale as

$$S(\lambda E, \lambda V, \lambda N) = \lambda S(E, V, N)$$

Quantities such as  $E$ ,  $V$ ,  $N$  and  $S$  which scale in this manner are called *extensive*. In contrast, the variables which arise from differentiating the entropy, such as temperature  $1/T = \partial S/\partial E$  and pressure  $p = T\partial S/\partial V$  and chemical potential  $\mu = T\partial S/\partial N$  involve the ratio of two extensive quantities and so do not change as we scale the system: they are called *intensive* quantities.

What now happens as we make successive Legendre transforms? The free energy  $F = E - TS$  is also extensive (since  $E$  and  $S$  are extensive while  $T$  is intensive). So it must scale as

$$F(T, \lambda V, \lambda N) = \lambda F(T, V, N) \quad (1.46)$$

Similarly, the grand potential  $\Phi = F - \mu N$  is extensive and scales as

$$\Phi(T, \lambda V, \mu) = \lambda \Phi(T, V, \mu) \quad (1.47)$$

But there's something special about this last equation, because  $\Phi$  only depends on a single extensive variable, namely  $V$ . While there are many ways to construct a free energy  $F$  which obeys (1.46) (for example, any function of the form  $F \sim V^{n+1}/N^n$  will do the job), there is only one way to satisfy (1.47):  $\Phi$  must be proportional to  $V$ . But we've already got a name for this proportionality constant: it is pressure. (Actually, it is minus the pressure as you can see from (1.44)). So we have the equation

$$\Phi(T, V, \mu) = -p(T, \mu)V \quad (1.48)$$

It looks as if we got something for free! If  $F$  is a complicated function of  $V$ , where do these complications go after the Legendre transform to  $\Phi$ ? The answer is that the complications go into the pressure  $p(T, \mu)$  when expressed as a function of  $T$  and  $\mu$ . Nonetheless, equation (1.48) will prove to be an extremely economic way to calculate the pressure of various systems.

#### 1.4.4 Josiah Willard Gibbs (1839-1903)

Gibbs was perhaps the first great American theoretical physicist. Many of the developments that we met in this chapter are due to him, including the free energy, the chemical potential and, most importantly, the idea of ensembles. Even the name “statistical mechanics” was invented by Gibbs.

Gibbs provided the first modern rendering of the subject in a treatise published shortly before his death. Very few understood it. Lord Rayleigh wrote to Gibbs suggesting that the book was “too condensed and too difficult for most, I might say all, readers”. Gibbs disagreed. He wrote back saying the book was only “too long”.

There do not seem to be many exciting stories about Gibbs. He was an undergraduate at Yale. He did a PhD at Yale. He became a professor at Yale. Apparently he rarely left New Haven. Strangely, he did not receive a salary for the first ten years of his professorship. Only when he received an offer from John Hopkins of \$3000 dollars a year did Yale think to pay America's greatest physicist. They made a counter-offer of \$2000 dollars and Gibbs stayed.

## 2. Classical Gases

Our goal in this section is to use the techniques of statistical mechanics to describe the dynamics of the simplest system: a gas. This means a bunch of particles, flying around in a box. Although much of the last section was formulated in the language of quantum mechanics, here we will revert back to classical mechanics. Nonetheless, a recurrent theme will be that the quantum world is never far behind: we'll see several puzzles, both theoretical and experimental, which can only truly be resolved by turning on  $\hbar$ .

### 2.1 The Classical Partition Function

For most of this section we will work in the canonical ensemble. We start by reformulating the idea of a partition function in classical mechanics. We'll consider a simple system – a single particle of mass  $m$  moving in three dimensions in a potential  $V(\vec{q})$ . The classical Hamiltonian of the system<sup>3</sup> is the sum of kinetic and potential energy,

$$H = \frac{\vec{p}^2}{2m} + V(\vec{q})$$

We earlier defined the partition function (1.21) to be the sum over all quantum states of the system. Here we want to do something similar. In classical mechanics, the state of a system is determined by a point in *phase space*. We must specify both the position and momentum of each of the particles — only then do we have enough information to figure out what the system will do for all times in the future. This motivates the definition of the partition function for a single classical particle as the integration over phase space,

$$Z_1 = \frac{1}{h^3} \int d^3q d^3p e^{-\beta H(p,q)} \quad (2.1)$$

The only slightly odd thing is the factor of  $1/h^3$  that sits out front. It is a quantity that needs to be there simply on dimensional grounds:  $Z$  should be dimensionless so  $h$  must have dimension (length  $\times$  momentum) or, equivalently, Joules-seconds ( $Js$ ). The actual value of  $h$  won't matter for any physical observable, like heat capacity, because we always take  $\log Z$  and then differentiate. Despite this, there is actually a correct value for  $h$ : it is Planck's constant,  $h = 2\pi\hbar \approx 6.6 \times 10^{-34} Js$ .

It is very strange to see Planck's constant in a formula that is supposed to be classical. What's it doing there? In fact, it is a vestigial object, like the male nipple. It is redundant, serving only as a reminder of where we came from. And the classical world came from the quantum.

---

<sup>3</sup>If you haven't taken the *Classical Dynamics* course, you should think of the Hamiltonian as the energy of the system expressed in terms of the position and momentum of the particle. More details can be found in the lecture notes at: <http://www.damtp.cam.ac.uk/user/tong/dynamics.html>

### 2.1.1 From Quantum to Classical

It is possible to derive the classical partition function (2.1) directly from the quantum partition function (1.21) without resorting to hand-waving. It will also show us why the factor of  $1/h$  sits outside the partition function. The derivation is a little tedious, but worth seeing. (Similar techniques are useful in later courses when you first meet the path integral). To make life easier, let's consider a single particle moving in one spatial dimension. It has position operator  $\hat{q}$ , momentum operator  $\hat{p}$  and Hamiltonian,

$$\hat{H} = \frac{\hat{p}^2}{2m} + V(\hat{q})$$

If  $|n\rangle$  is the energy eigenstate with energy  $E_n$ , the quantum partition function is

$$Z_1 = \sum_n e^{-\beta E_n} = \sum_n \langle n | e^{-\beta \hat{H}} | n \rangle \quad (2.2)$$

In what follows, we'll make liberal use of the fact that we can insert the identity operator anywhere in this expression. Identity operators can be constructed by summing over any complete basis of states. We'll need two such constructions, using the position eigenvectors  $|q\rangle$  and the momentum eigenvectors  $|p\rangle$ ,

$$\mathbf{1} = \int dq |q\rangle \langle q| \quad , \quad \mathbf{1} = \int dp |p\rangle \langle p|$$

We start by inserting two copies of the identity built from position eigenstates,

$$\begin{aligned} Z_1 &= \sum_n \langle n | \int dq |q\rangle \langle q| e^{-\beta \hat{H}} \int dq' |q'\rangle \langle q'| n \rangle \\ &= \int dq dq' \langle q | e^{-\beta \hat{H}} | q' \rangle \sum_n \langle q' | n \rangle \langle n | q \rangle \end{aligned}$$

But now we can replace  $\sum_n |n\rangle \langle n|$  with the identity matrix and use the fact that  $\langle q' | q \rangle = \delta(q' - q)$ , to get

$$Z_1 = \int dq \langle q | e^{-\beta \hat{H}} | q \rangle \quad (2.3)$$

We see that the result is to replace the sum over energy eigenstates in (2.2) with a sum (or integral) over position eigenstates in (2.3). If you wanted, you could play the same game and get the sum over any complete basis of eigenstates of your choosing. As an aside, this means that we can write the partition function in a basis independent fashion as

$$Z_1 = \text{Tr} e^{-\beta \hat{H}}$$

So far, our manipulations could have been done for any quantum system. Now we want to use the fact that we are taking the classical limit. This comes about when we try to factorize  $e^{-\beta\hat{H}}$  into a momentum term and a position term. The trouble is that this isn't always possible when there are matrices (or operators) in the exponent. Recall that,

$$e^{\hat{A}}e^{\hat{B}} = e^{\hat{A}+\hat{B}+\frac{1}{2}[\hat{A},\hat{B}]+\dots}$$

For us  $[\hat{q}, \hat{p}] = i\hbar$ . This means that if we're willing to neglect terms of order  $\hbar$  — which is the meaning of taking the classical limit — then we can write

$$e^{-\beta\hat{H}} = e^{-\beta\hat{p}^2/2m} e^{-\beta V(\hat{q})} + \mathcal{O}(\hbar)$$

We can now start to replace some of the operators in the exponent, like  $V(\hat{q})$ , with functions  $V(q)$ . (The notational difference is subtle, but important, in the expressions below!),

$$\begin{aligned} Z_1 &= \int dq \langle q | e^{-\beta\hat{p}^2/2m} e^{-\beta V(\hat{q})} | q \rangle \\ &= \int dq e^{-\beta V(q)} \langle q | e^{-\beta\hat{p}^2/2m} | q \rangle \\ &= \int dq dp dp' e^{-\beta V(q)} \langle q | p \rangle \langle p | e^{-\beta\hat{p}^2/2m} | p' \rangle \langle p' | q \rangle \\ &= \frac{1}{2\pi\hbar} \int dq dp e^{-\beta H(p,q)} \end{aligned}$$

where, in the final line, we've used the identity

$$\langle q | p \rangle = \frac{1}{\sqrt{2\pi\hbar}} e^{ipq/\hbar}$$

This completes the derivation.

## 2.2 Ideal Gas

The first classical gas that we'll consider consists of  $N$  particles trapped inside a box of volume  $V$ . The gas is “ideal”. This simply means that the particles do not interact with each other. For now, we'll also assume that the particles have no internal structure, so no rotational or vibrational degrees of freedom. This situation is usually referred to as the monatomic ideal gas. The Hamiltonian for each particle is simply the kinetic energy,

$$H = \frac{\vec{p}^2}{2m}$$

And the partition function for a single particle is

$$Z_1(V, T) = \frac{1}{(2\pi\hbar)^3} \int d^3q d^3p e^{-\beta\vec{p}^2/2m} \quad (2.4)$$

The integral over position is now trivial and gives  $\int d^3q = V$ , the volume of the box. The integral over momentum is also straightforward since it factorizes into separate integrals over  $p_x$ ,  $p_y$  and  $p_z$ , each of which is a Gaussian of the form,

$$\int dx e^{-ax^2} = \sqrt{\frac{\pi}{a}}$$

So we have

$$Z_1 = V \left( \frac{mk_B T}{2\pi\hbar^2} \right)^{3/2}$$

We'll meet the combination of factors in the brackets a lot in what follows, so it is useful to give it a name. We'll write

$$Z_1 = \frac{V}{\lambda^3} \quad (2.5)$$

The quantity  $\lambda$  goes by the name of the *thermal de Broglie wavelength*,

$$\lambda = \sqrt{\frac{2\pi\hbar^2}{mk_B T}} \quad (2.6)$$

$\lambda$  has the dimensions of length. We will see later that you can think of  $\lambda$  as something like the average de Broglie wavelength of a particle at temperature  $T$ . Notice that it is a quantum object – it has an  $\hbar$  sitting in it – so we expect that it will drop out of any genuinely classical quantity that we compute. The partition function itself (2.5) is counting the number of these thermal wavelengths that we can fit into volume  $V$ .

$Z_1$  is the partition function for a single particle. We have  $N$ , non-interacting, particles in the box so the partition function of the whole system is

$$Z(N, V, T) = Z_1^N = \frac{V^N}{\lambda^{3N}} \quad (2.7)$$

(Full disclosure: there's a slightly subtle point that we're brushing under the carpet here and this equation isn't quite right. This won't affect our immediate discussion and we'll explain the issue in more detail in Section 2.2.3.)



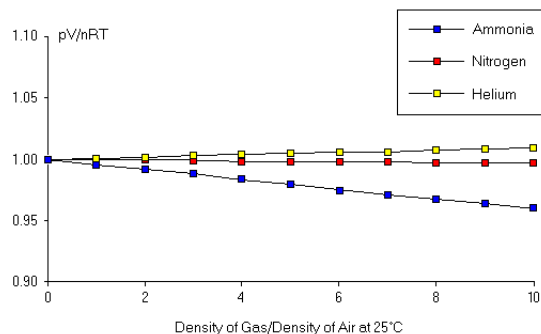

**Figure 8:** Deviations from ideal gas law at sensible densities

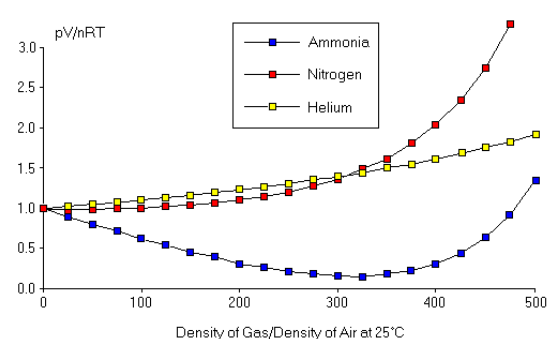

**Figure 9:** Deviations from ideal gas law at extreme densities

Armed with the partition function  $Z$ , we can happily calculate anything that we like. Let's start with the pressure, which can be extracted from the partition function by first computing the free energy (1.36) and then using (1.35). We have

$$\begin{aligned}
 p &= -\frac{\partial F}{\partial V} \\
 &= \frac{\partial}{\partial V}(k_B T \log Z) \\
 &= \frac{Nk_B T}{V}
 \end{aligned} \tag{2.8}$$

This equation is an old friend – it is the ideal gas law,  $pV = Nk_B T$ , that we all met in kindergarten. Notice that the thermal wavelength  $\lambda$  has indeed disappeared from the discussion as expected. Equations of this form, which link pressure, volume and temperature, are called *equations of state*. We will meet many throughout this course.

As the plots above show<sup>4</sup>, the ideal gas law is an extremely good description of gases at low densities. Gases deviate from this ideal behaviour as the densities increase and the interactions between atoms becomes important. We will see how this comes about from the viewpoint of microscopic forces in Section 2.5.

It is worth pointing out that this derivation should calm any lingering fears that you had about the definition of temperature given in (1.7). The object that we call  $T$  really does coincide with the familiar notion of temperature applied to gases. But the key property of the temperature is that if two systems are in equilibrium then they have the same  $T$ . That's enough to ensure that equation (1.7) is the right definition of temperature for *all* systems because we can always put any system in equilibrium with an ideal gas.

<sup>4</sup>Both figures are taken from the web textbook “*General Chemistry*” and credited to John Hutchinson.

### 2.2.1 Equipartition of Energy

The partition function (2.7) has more in store for us. We can compute the average energy of the ideal gas,

$$E = -\frac{\partial}{\partial\beta} \log Z = \frac{3}{2}Nk_B T \quad (2.9)$$

There's an important, general lesson lurking in this formula. To highlight this, it is worth repeating our analysis for an ideal gas in arbitrary number of spatial dimensions,  $D$ . A simple generalization of the calculations above shows that

$$Z = \frac{V^N}{\lambda^{DN}} \quad \Rightarrow \quad E = \frac{D}{2}Nk_B T$$

Each particle has  $D$  degrees of freedom (because it can move in one of  $D$  spatial directions). And each particle contributes  $\frac{1}{2}Dk_B T$  towards the average energy. This is a general rule of thumb, which holds for all classical systems: the average energy of each free degree of freedom in a system at temperature  $T$  is  $\frac{1}{2}k_B T$ . This is called the *equipartition of energy*. As stated, it holds only for degrees of freedom in the absence of a potential. (There is a modified version if you include a potential). Moreover, it holds only for classical systems or quantum systems at suitably high temperatures.

We can use the result above to see why the thermal de Broglie wavelength (2.6) can be thought of as roughly equal to the average de Broglie wavelength of a particle. Equating the average energy (2.9) to the kinetic energy  $E = p^2/2m$  tells us that the average (root mean square) momentum carried by each particle is  $p \sim \sqrt{mk_B T}$ . In quantum mechanics, the de Broglie wavelength of a particle is  $\lambda_{dB} = h/p$ , which (up to numerical factors of 2 and  $\pi$ ) agrees with our formula (2.6).

Finally, returning to the reality of  $d = 3$  dimensions, we can compute the heat capacity for a monatomic ideal gas. It is

$$C_V = \left. \frac{\partial E}{\partial T} \right|_V = \frac{3}{2}Nk_B \quad (2.10)$$

### 2.2.2 The Sociological Meaning of Boltzmann's Constant

We introduced Boltzmann's constant  $k_B$  in our original the definition of entropy (1.2). It has the value,

$$k_B = 1.381 \times 10^{-23} \text{ JK}^{-1}$$

In some sense, there is no deep physical meaning to Boltzmann's constant. It is merely a conversion factor that allows us to go between temperature and energy, as reflected

in (1.7). It is necessary to include it in the equations only for historical reasons: our ancestors didn't realise that temperature and energy were closely related and measured them in different units.

Nonetheless, we could ask why does  $k_B$  have the value above? It doesn't seem a particularly natural number. The reason is that both the units of temperature (Kelvin) and energy (Joule) are picked to reflect the conditions of human life. In the everyday world around us, measurements of temperature and energy involve fairly ordinary numbers: room temperature is roughly  $300\text{ K}$ ; the energy required to lift an apple back up to the top of the tree is a few Joules. Similarly, in an everyday setting, all the measurable quantities —  $p$ ,  $V$  and  $T$  — in the ideal gas equation are fairly normal numbers when measured in SI units. The only way this can be true is if the combination  $Nk_B$  is a fairly ordinary number, of order one. In other words the number of atoms must be huge,

$$N \sim 10^{23} \tag{2.11}$$

This then is the real meaning of the value of Boltzmann's constant: *atoms are small*.

It's worth stressing this point. Atoms aren't just small: they're really really small.  $10^{23}$  is an astonishingly large number. The number of grains of sand in all the beaches in the world is around  $10^{18}$ . The number of stars in our galaxy is about  $10^{11}$ . The number of stars in the entire visible Universe is probably around  $10^{22}$ . And yet the number of water molecules in a cup of tea is more than  $10^{23}$ .

### Chemist Notation

While we're talking about the size of atoms, it is probably worth reminding you of the notation used by chemists. They too want to work with numbers of order one. For this reason, they define a *mole* to be the number of atoms in one gram of Hydrogen. (Actually, it is the number of atoms in 12 grams of Carbon-12, but this is roughly the same thing). The mass of Hydrogen is  $1.6 \times 10^{-27}\text{ Kg}$ , so the number of atoms in a mole is Avogadro's number,

$$N_A \approx 6 \times 10^{23}$$

The number of moles in our gas is then  $n = N/N_A$  and the ideal gas law can be written as

$$pV = nRT$$

where  $R = N_A k_B$  is called the Universal gas constant. Its value is a nice sensible number with no silly power in the exponent:  $R \approx 8\text{ JK}^{-1}\text{mol}^{-1}$ .

### 2.2.3 Entropy and Gibbs's Paradox

“It has always been believed that Gibbs's paradox embodied profound thought. That it was intimately linked up with something so important and entirely new could hardly have been foreseen.”

*Erwin Schrödinger*

We said earlier that the formula for the partition function (2.7) isn't quite right. What did we miss? We actually missed a subtle point from quantum mechanics: quantum particles are indistinguishable. If we take two identical atoms and swap their positions, this doesn't give us a new state of the system – it is the same state that we had before. (Up to a sign that depends on whether the atoms are bosons or fermions – we'll discuss this aspect in more detail in Sections 3.5 and 3.6). However, we haven't taken this into account – we wrote the expression  $Z = Z_1^N$  which would be true if all the  $N$  particles in the were distinguishable — for example, if each of the particles were of a different type. But this naive partition function overcounts the number of states in the system when we're dealing with indistinguishable particles.

It is a simple matter to write down the partition function for  $N$  indistinguishable particles. We simply need to divide by the number of ways to permute the particles. In other words, for the ideal gas the partition function is

$$Z_{\text{ideal}}(N, V, T) = \frac{1}{N!} Z_1^N = \frac{V^N}{N! \lambda^{3N}} \quad (2.12)$$

The extra factor of  $N!$  doesn't change the calculations of pressure or energy since, for each, we had to differentiate  $\log Z$  and any overall factor drops out. However, it does change the entropy since this is given by,

$$S = \frac{\partial}{\partial T} (k_B T \log Z_{\text{ideal}})$$

which includes a factor of  $\log Z$  without any derivative. Of course, since the entropy is counting the number of underlying microstates, we would expect it to know about whether particles are distinguishable or indistinguishable. Using the correct partition function (2.12) and Stirling's formula, the entropy of an ideal gas is given by,

$$S = Nk_B \left[ \log \left( \frac{V}{N\lambda^3} \right) + \frac{5}{2} \right] \quad (2.13)$$

This result is known as the *Sackur-Tetrode* equation. Notice that not only is the entropy sensitive to the indistinguishability of the particles, but it also depends on  $\lambda$ . However, the entropy is not directly measurable classically. We can only measure entropy differences by the integrating the heat capacity as in (1.10).

The necessity of adding an extra factor of  $N!$  was noticed before the advent of quantum mechanics by Gibbs. He was motivated by the change in entropy of mixing between two gases. Suppose that we have two different gases, say red and blue. Each has the same number of particles  $N$  and sits in a volume  $V$ , separated by a partition. When the partition is removed the gases mix and we expect the entropy to increase. But if the gases are of the same type, removing the partition shouldn't change the macroscopic state of the gas. So why should the entropy increase? This was referred to as the *Gibb's paradox*. Including the factor of  $N!$  in the partition function ensures that the entropy does not increase when identical atoms are mixed.

## 2.2.4 The Ideal Gas in the Grand Canonical Ensemble

It is worth briefly looking at the ideal gas in the grand canonical ensemble. Recall that in such an ensemble, the gas is free to exchange both energy and particles with the outside reservoir. You could think of the system as some fixed subvolume inside a much larger gas. If there are no walls to define this subvolume then particles, and hence energy, can happily move in and out. We can ask how many particles will, on average, be inside this volume and what fluctuations in particle number will occur. More importantly, we can also start to gain some intuition for this strange quantity called the chemical potential,  $\mu$ .

The grand partition function (1.39) for the ideal gas is

$$\mathcal{Z}_{\text{ideal}}(\mu, V, T) = \sum_{N=0}^{\infty} e^{\beta\mu N} Z_{\text{ideal}}(N, V, T) = \exp\left(\frac{e^{\beta\mu} V}{\lambda^3}\right)$$

From this we can determine the average particle number,

$$N = \frac{1}{\beta} \frac{\partial}{\partial \mu} \log \mathcal{Z} = \frac{e^{\beta\mu} V}{\lambda^3}$$

Which, rearranging, gives

$$\mu = k_B T \log\left(\frac{\lambda^3 N}{V}\right) \tag{2.14}$$

If  $\lambda^3 < V/N$  then the chemical potential is negative. Recall that  $\lambda$  is roughly the average de Broglie wavelength of each particle, while  $V/N$  is the average volume taken up by each particle. But whenever the de Broglie wavelength of particles becomes comparable to the inter-particle separation, then quantum effects become important. In other words, to trust our classical calculation of the ideal gas, we must have  $\lambda^3 \ll V/N$  and, correspondingly,  $\mu < 0$ .

At first sight, it is slightly strange that  $\mu$  is negative. When we introduced  $\mu$  in Section 1.4.1, we said that it should be thought of as the energy cost of adding an extra particle to the system. Surely that energy should be positive! To see why this isn't the case, we should look more closely at the definition. From the energy variation (1.38), we have

$$\mu = \left. \frac{\partial E}{\partial N} \right|_{S,V}$$

So the chemical potential should be thought of as the energy cost of adding an extra particle *at fixed entropy and volume*. But adding a particle will give more ways to share the energy around and so increase the entropy. If we insist on keeping the entropy fixed, then we will need to reduce the energy when we add an extra particle. This is why we have  $\mu < 0$  for the classical ideal gas.

There are situations where  $\mu > 0$ . This can occur if we have a suitably strong repulsive interaction between particles so that there's a large energy cost associated to throwing in one extra. We also have  $\mu > 0$  for fermion systems at low temperatures as we will see in Section 3.6.

We can also compute the fluctuation in the particle number,

$$\Delta N^2 = \frac{1}{\beta^2} \frac{\partial^2}{\partial \mu^2} \log \mathcal{Z}_{\text{ideal}} = N$$

As promised in Section 1.4.1, the relative fluctuations  $\Delta N / \langle N \rangle = 1/\sqrt{N}$  are vanishingly small in the thermodynamic  $N \rightarrow \infty$  limit.

Finally, it is very easy to compute the equation of state in the grand canonical ensemble because (1.45) and (1.48) tell us that

$$pV = k_B T \log \mathcal{Z} = k_B T \frac{e^{\beta \mu V}}{\lambda^3} = k_B T N \quad (2.15)$$

which gives us back the ideal gas law.

### 2.3 Maxwell Distribution

Our discussion above focusses on understanding macroscopic properties of the gas such as pressure or heat capacity. But we can also use the methods of statistical mechanics to get a better handle on the microscopic properties of the gas. Like everything else, the information is hidden in the partition function. Let's return to the form of the single particle partition function (2.4) before we do the integrals. We'll still do the

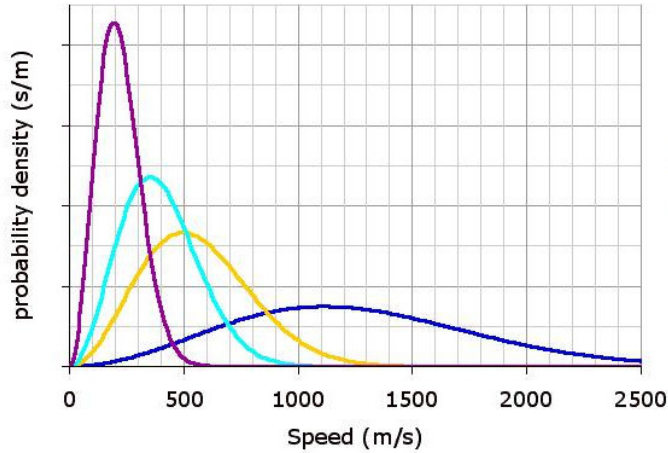

**Figure 10:** Maxwell distribution for Noble gases: *He*, *Ne*, *Ar* and *Xe*.

trivial spatial integral  $\int d^3q = V$ , but we'll hold off on the momentum integral and instead change variables from momentum to velocity,  $\vec{p} = m\vec{v}$ . Then the single particle partition function is

$$Z_1 = \frac{m^3V}{(2\pi\hbar)^3} \int d^3v e^{-\beta m\vec{v}^2/2} = \frac{4\pi m^3V}{(2\pi\hbar)^3} \int dv v^2 e^{-\beta mv^2/2}$$

We can compare this to the original definition of the partition function: the sum over states of the probability of that state. But here too, the partition function is written as a sum, now over speeds. The integrand must therefore have the interpretation as the probability distribution over speeds. The probability that the atom has speed between  $v$  and  $v + dv$  is

$$f(v)dv = \mathcal{N}v^2 e^{-mv^2/2k_B T} dv \tag{2.16}$$

where the normalization factor  $\mathcal{N}$  can be determined by insisting that probabilities sum to one,  $\int_0^\infty f(v) dv = 1$ , which gives

$$\mathcal{N} = 4\pi \left( \frac{m}{2\pi k_B T} \right)^{3/2}$$

This is the *Maxwell distribution*. It is sometimes called the Maxwell-Boltzmann distribution. Figure 10 shows this distribution for a variety of gases with different masses at the same temperature, from the slow heavy Xenon (purple) to light, fast Helium (blue). We can use it to determine various average properties of the speeds of atoms

in a gas. For example, the mean square speed is

$$\langle v^2 \rangle = \int_0^\infty dv v^2 f(v) = \frac{3k_B T}{m}$$

This is in agreement with the equipartition of energy: the average kinetic energy of the gas is  $E = \frac{1}{2}m\langle v^2 \rangle = \frac{3}{2}k_B T$ .

### Maxwell's Argument

The above derivation tells us the distribution of velocities in a non-interacting gas of particles. Remarkably, the Maxwell distribution also holds in the presence of any interactions. In fact, Maxwell's original derivation of the distribution makes no reference to any properties of the gas. It is very slick!

Let's first think about the distribution of velocities in the  $x$  direction; we'll call this distribution  $\phi(v_x)$ . Rotational symmetry means that we must have the same distribution of velocities in both the  $y$  and  $z$  directions. However, rotational invariance also requires that the full distribution can't depend on the direction of the velocity; it can only depend on the speed  $v = \sqrt{v_x^2 + v_y^2 + v_z^2}$ . This means that we need to find functions  $F(v)$  and  $\phi(v_x)$  such that

$$F(v) dv_x dv_y dv_z = \phi(v_x)\phi(v_y)\phi(v_z) dv_x dv_y dv_z$$

It doesn't look as if we possibly have enough information to solve this equation for both  $F$  and  $\phi$ . But, remarkably, there is only one solution. The only function which satisfies this equation is

$$\phi(v_x) = A e^{-Bv_x^2}$$

for some constants  $A$  and  $B$ . Thus the distribution over speeds must be

$$F(v) dv_x dv_y dv_z = 4\pi v^2 F(v) dv = 4\pi A^3 v^2 e^{-Bv^2} dv$$

We see that the functional form of the distribution arises from rotational invariance alone. To determine the coefficient  $B = m/2k_B T$  we need the more elaborate techniques of statistical mechanics that we saw above. (In fact, one can derive it just from equipartition of energy).

#### 2.3.1 A History of Kinetic Theory

The name *kinetic theory* refers to the understanding the properties of gases through their underlying atomic constituents. The discussion given above barely scratches the surface of this important subject.



Kinetic theory traces its origin to the work of Daniel Bernoulli in 1738. He was the first to argue that the phenomenon that we call pressure is due to the constant bombardment of tiny atoms. His calculation is straightforward. Consider a cubic box with sides of length  $L$ . Suppose that an atom travelling with momentum  $v_x$  in the  $x$  direction bounces elastically off a wall so that it returns with velocity  $-v_x$ . The particle experiences a change in momentum is  $\Delta p_x = 2mv_x$ . Since the particle is trapped in a box, it will next hit the wall at a time  $\Delta t = 2L/v_x$  later. This means that the force on the wall due to this atom is

$$F = \frac{\Delta p_x}{\Delta t} = \frac{mv_x^2}{L}$$

Summing over all the atoms which hit the wall, the force is

$$F = \frac{Nm\langle v_x^2 \rangle}{L}$$

where  $\langle v_x^2 \rangle$  is the average velocity in the  $x$ -direction. Using the same argument as we gave in Maxwell's derivation above, we must have  $\langle v_x^2 \rangle = \langle v^2 \rangle / 3$ . Thus  $F = Nm\langle v^2 \rangle / 3L$  and the pressure, which is force per area, is given by

$$p = \frac{Nm\langle v^2 \rangle}{3L^3} = \frac{Nm\langle v^2 \rangle}{3V}$$

If this equation is compared to the ideal gas law (which, at the time, had only experimental basis) one concludes that the phenomenon of temperature must arise from the kinetic energy of the gas. Or, more precisely, one finds the equipartition result that we derived previously:  $\frac{1}{2}m\langle v^2 \rangle = \frac{3}{2}k_B T$ .

After Bernoulli's pioneering work, kinetic theory languished. No one really knew what to do with his observation nor how to test the underlying atomic hypothesis. Over the next century, Bernoulli's result was independently rediscovered by a number of people, all of whom were ignored by the scientific community. One of the more interesting attempts was by John Waterson, a Scottish engineer and naval instructor working for the East India Company in Bombay. Waterson was considered a crackpot. His 1843 paper was rejected by the Royal Society as "nothing but nonsense" and he wrote up his results in a self-published book with the wonderfully crackpot title "Thoughts on Mental Functions".

The results of Bernoulli and Waterson finally became accepted only after they were re-discovered by more established scientists, most notably Rudolph Clausius who, in 1857, extended these ideas to rotating and vibrating molecules. Soon afterwards, in

1859, Maxwell gave the derivation of the distribution of velocities that we saw above. This is often cited as the first statistical law of physics. But Maxwell was able to take things further. He used kinetic theory to derive the first genuinely new prediction of the atomic hypothesis: that the viscosity of a gas is independent of its density. Maxwell himself wrote,

*“Such a consequence of the mathematical theory is very startling and the only experiment I have met with on the subject does not seem to confirm it.”*

Maxwell decided to rectify the situation. With help from his wife, he spent several years constructing an experimental apparatus in his attic which was capable of providing the first accurate measurements of viscosity of gases<sup>5</sup>. His surprising theoretical prediction was confirmed by his own experiment.

There are many further developments in kinetic theory which we will not cover in this course. Perhaps the most important is the Boltzmann equation. This describes the evolution of a particle’s probability distribution in position and momentum space as it collides with other particles. Stationary, unchanging, solutions bring you back to the Maxwell-Boltzmann distribution, but the equation also provides a framework to go beyond the equilibrium description of a gas. You can read about this in the lecture notes on Kinetic Theory.

## 2.4 Diatomic Gas

“I must now say something about these internal motions, because the greatest difficulty which the kinetic theory of gases has yet encountered belongs to this part of the subject”.

*James Clerk Maxwell, 1875*

Consider a molecule that consists of two atoms in a bound state. We’ll construct a very simple physicist’s model of this molecule: two masses attached to a spring. As well as the translational degrees of freedom, there are two further ways in which the molecule can move

- Rotation: the molecule can rotate rigidly about the two axes perpendicular to the axis of symmetry, with moment of inertia  $I$ . (For now, we will neglect the

---

<sup>5</sup>You can see the original apparatus down the road in the corridor of the Cavendish lab. Or, if you don’t fancy the walk, you can simply click here:

<http://www-outreach.phy.cam.ac.uk/camphy/museum/area1/exhibit1.htm>

rotation about the axis of symmetry. It has very low moment of inertia which will ultimately mean that it is unimportant).

- Vibration: the molecule can oscillate along the axis of symmetry

We'll work under the assumption that the rotation and vibration modes are independent. In this case, the partition function for a single molecule factorises into the product of the translation partition function  $Z_{\text{trans}}$  that we have already calculated (2.5) and the rotational and vibrational contributions,

$$Z_1 = Z_{\text{trans}} Z_{\text{rot}} Z_{\text{vib}}$$

We will now deal with  $Z_{\text{rot}}$  and  $Z_{\text{vib}}$  in turn.

### Rotation

The Lagrangian for the rotational degrees of freedom is<sup>6</sup>

$$L_{\text{rot}} = \frac{1}{2} I (\dot{\theta}^2 + \sin^2 \theta \dot{\phi}^2) \quad (2.17)$$

The conjugate momenta are therefore

$$p_{\theta} = \frac{\partial L_{\text{rot}}}{\partial \dot{\theta}} = I \dot{\theta} \quad , \quad p_{\phi} = \frac{\partial L_{\text{rot}}}{\partial \dot{\phi}} = I \sin^2 \theta \dot{\phi}$$

from which we get the Hamiltonian for the rotating diatomic molecule,

$$H_{\text{rot}} = \dot{\theta} p_{\theta} + \dot{\phi} p_{\phi} - L = \frac{p_{\theta}^2}{2I} + \frac{p_{\phi}^2}{2I \sin^2 \theta} \quad (2.18)$$

The rotational contribution to the partition function is then

$$\begin{aligned} Z_{\text{rot}} &= \frac{1}{(2\pi\hbar)^2} \int d\theta d\phi dp_{\theta} dp_{\phi} e^{-\beta H_{\text{rot}}} \\ &= \frac{1}{(2\pi\hbar)^2} \sqrt{\frac{2\pi I}{\beta}} \int_0^{\pi} d\theta \sqrt{\frac{2\pi I \sin^2 \theta}{\beta}} \int_0^{2\pi} d\phi \\ &= \frac{2Ik_B T}{\hbar^2} \end{aligned} \quad (2.19)$$

From this we can compute the average rotational energy of each molecule,

$$E_{\text{rot}} = k_B T$$

---

<sup>6</sup>See, for example, Section 3.6 of the lecture notes on Classical Dynamics

If we now include the translational contribution (2.5), the partition function for a diatomic molecule that can spin and move, but can't vibrate, is given by  $Z_1 = Z_{\text{trans}}Z_{\text{rot}} \sim (k_B T)^{5/2}$ , and the partition function for a gas of these object  $Z = Z_1^N/N!$ , from which we compute the energy  $E = \frac{5}{2}Nk_B T$  and the heat capacity,

$$C_V = \frac{5}{2}k_B N$$

In fact we can derive this result simply from equipartition of energy: there are 3 translational modes and 2 rotational modes, giving a contribution of  $5N \times \frac{1}{2}k_B T$  to the energy.

### Vibrations

The Hamiltonian for the vibrating mode is simply a harmonic oscillator. We'll denote the displacement away from the equilibrium position by  $\zeta$ . The molecule vibrates with some frequency  $\omega$  which is determined by the strength of the atomic bond. The Hamiltonian is then

$$H_{\text{vib}} = \frac{p_\zeta^2}{2m} + \frac{1}{2}m\omega^2\zeta^2$$

from which we can compute the partition function

$$Z_{\text{vib}} = \frac{1}{2\pi\hbar} \int d\zeta dp_\zeta e^{-\beta H_{\text{vib}}} = \frac{k_B T}{\hbar\omega} \quad (2.20)$$

The average vibrational energy of each molecule is now

$$E_{\text{vib}} = k_B T$$

(You may have anticipated  $\frac{1}{2}k_B T$  since the harmonic oscillator has just a single degree of freedom, but equipartition works slightly differently when there is a potential energy. You will see another example on the problem sheet from which it is simple to deduce the general form).

Putting together all the ingredients, the contributions from translational motion, rotation and vibration give the heat capacity

$$C_V = \frac{7}{2}Nk_B$$

This result depends on neither the moment of inertia,  $I$ , nor the stiffness of the molecular bond,  $\omega$ . A molecule with large  $I$  will simply spin more slowly so that the average rotational kinetic energy is  $k_B T$ ; a molecule attached by a stiff spring with high  $\omega$  will vibrate with smaller amplitude so that the average vibrational energy is  $k_B T$ . This ensures that the heat capacity is constant.

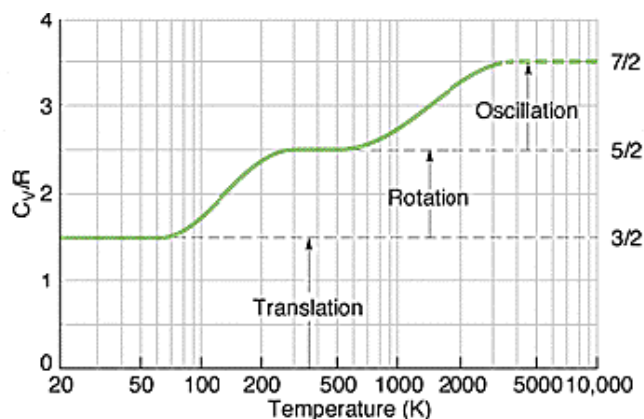

**Figure 11:** The heat capacity of Hydrogen gas  $H_2$ . The graph was created by P. Eyland.

Great! So the heat capacity of a diatomic gas is  $\frac{7}{2}Nk_B T$ . Except it's not! An idealised graph of the heat capacity for  $H_2$ , the simplest diatomic gas, is shown in Figure 11. At suitably high temperatures, around  $5000K$ , we do see the full heat capacity that we expect. But at low temperatures, the heat capacity is that of monatomic gas. And, in the middle, it seems to rotate, but not vibrate. What's going on? Towards the end of the nineteenth century, scientists were increasingly bewildered about this behaviour.

What's missing in the discussion above is something *very* important:  $\hbar$ . The successive freezing out of vibrational and rotational modes as the temperature is lowered is a quantum effect. In fact, this behaviour of the heat capacities of gases was the first time that quantum mechanics revealed itself in experiment. We're used to thinking of quantum mechanics as being relevant on small scales, yet here we see that affects the physics of gases at temperatures of  $2000 K$ . But then, that is the theme of this course: how the microscopic determines the macroscopic. We will return to the diatomic gas in Section 3.4 and understand its heat capacity including the relevant quantum effects.

## 2.5 Interacting Gas

Until now, we've only discussed free systems; particles moving around unaware of each other. Now we're going to turn on interactions. Here things get much more interesting. And much more difficult. Many of the most important unsolved problems in physics are to do with the interactions between large number of particles. Here we'll be gentle. We'll describe a simple approximation scheme that will allow us to begin to understand the effects of interactions between particles.

We'll focus once more on the monatomic gas. The ideal gas law is exact in the limit of no interactions between atoms. This is a good approximation when the density of atoms  $N/V$  is small. Corrections to the ideal gas law are often expressed in terms of a density expansion, known as the *virial expansion*. The most general equation of state is,

$$\frac{p}{k_B T} = \frac{N}{V} + B_2(T) \frac{N^2}{V^2} + B_3(T) \frac{N^3}{V^3} + \dots \quad (2.21)$$

where the functions  $B_j(T)$  are known as virial coefficients.

Our goal is to compute the virial coefficients from first principles, starting from a knowledge of the underlying potential energy  $U(r)$  between two neutral atoms separated by a distance  $r$ . This potential has two important features:

- An attractive  $1/r^6$  force. This arises from fluctuating dipoles of the neutral atoms. Recall that two permanent dipole moments,  $p_1$  and  $p_2$ , have a potential energy which scales as  $p_1 p_2 / r^3$ . Neutral atoms don't have permanent dipoles, but they can acquire a temporary dipole due to quantum fluctuations. Suppose that the first atom has an instantaneous dipole  $p_1$ . This will induce an electric field which is proportional to  $E \sim p_1 / r^3$  which, in turn, will induce a dipole of the second atom  $p_2 \sim E \sim p_1 / r^3$ . The resulting potential energy between the atoms scales as  $p_1 p_2 / r^3 \sim 1/r^6$ . This is sometimes called the *van der Waals* interaction.
- A rapidly rising repulsive interaction at short distances, arising from the Pauli exclusion principle that prevents two atoms from occupying the same space. For our purposes, the exact form of this repulsion is not so relevant: just as long as it's big. (The Pauli exclusion principle is a quantum effect. If the exact form of the potential is important then we really need to be dealing with quantum mechanics all along. We will do this in the next section).

One very common potential that is often used to model the force between atoms is the *Lennard-Jones potential*,

$$U(r) \sim \left(\frac{r_0}{r}\right)^{12} - \left(\frac{r_0}{r}\right)^6 \quad (2.22)$$

The exponent 12 is chosen only for convenience: it simplifies certain calculations because  $12 = 2 \times 6$ .

An even simpler form of the potential incorporates a *hard core repulsion*, in which

the particles are simply forbidden from closer than a fixed distance by imposing an infinite potential,

$$U(r) = \begin{cases} \infty & r < r_0 \\ -U_0 \left(\frac{r_0}{r}\right)^6 & r \geq r_0 \end{cases} \quad (2.23)$$

The hard-core potential with van der Waals attraction is sketched to the right. We will see shortly that the virial coefficients are determined by increasingly difficult integrals involving the potential  $U(r)$ . For this reason, it's best to work with a potential that's as simple as possible. When we come to do some actual calculations we will use the form (2.23).

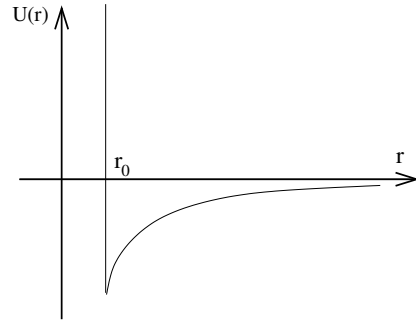

**Figure 12:**

### 2.5.1 The Mayer f Function and the Second Virial Coefficient

We're going to change notation and call the positions of the particles  $\vec{r}$  instead of  $\vec{q}$ . (The latter notation was useful to stress the connection to quantum mechanics at the beginning of this Section, but we've now left that behind!). The Hamiltonian of the gas is

$$H = \sum_{i=1}^N \frac{p_i^2}{2m} + \sum_{i>j} U(r_{ij})$$

where  $r_{ij} = |\vec{r}_i - \vec{r}_j|$  is the separation between particles. The restriction  $i > j$  on the final sum ensures that we sum over each pair of particles exactly once. The partition function is then

$$\begin{aligned} Z(N, V, T) &= \frac{1}{N!} \frac{1}{(2\pi\hbar)^{3N}} \int \prod_{i=1}^N d^3 p_i d^3 r_i e^{-\beta H} \\ &= \frac{1}{N!} \frac{1}{(2\pi\hbar)^{3N}} \left[ \int \prod_i d^3 p_i e^{-\beta \sum_j p_j^2/2m} \right] \times \left[ \int \prod_i d^3 r_i e^{-\beta \sum_{j<k} U(r_{jk})} \right] \\ &= \frac{1}{N! \lambda^{3N}} \int \prod_i d^3 r_i e^{-\beta \sum_{j<k} U(r_{jk})} \end{aligned}$$

where  $\lambda$  is the thermal wavelength that we met in (2.6). We still need to do the integral over positions. And that looks hard! The interactions mean that the integrals don't factor in any obvious way. What to do? One obvious way thing to try is to Taylor expand (which is closely related to the so-called *cumulant expansion* in this context)

$$e^{-\beta \sum_{j<k} U(r_{jk})} = 1 - \beta \sum_{j<k} U(r_{jk}) + \frac{\beta^2}{2} \sum_{j<k, l<m} U(r_{jk}) U(r_{lm}) + \dots$$

Unfortunately, this isn't so useful. We want each term to be smaller than the preceding one. But as  $r_{ij} \rightarrow 0$ , the potential  $U(r_{ij}) \rightarrow \infty$ , which doesn't look promising for an expansion parameter.

Instead of proceeding with the naive Taylor expansion, we will instead choose to work with the following quantity, usually called the *Mayer f function*,

$$f(r) = e^{-\beta U(r)} - 1 \quad (2.24)$$

This is a nicer expansion parameter. When the particles are far separated at  $r \rightarrow \infty$ ,  $f(r) \rightarrow 0$ . However, as the particles come close and  $r \rightarrow 0$ , the Mayer function approaches  $f(r) \rightarrow -1$ . We'll proceed by trying to construct a suitable expansion in terms of  $f$ . We define

$$f_{ij} = f(r_{ij})$$

Then we can write the partition function as

$$\begin{aligned} Z(N, V, T) &= \frac{1}{N! \lambda^{3N}} \int \prod_i d^3 r_i \prod_{j>k} (1 + f_{jk}) \\ &= \frac{1}{N! \lambda^{3N}} \int \prod_i d^3 r_i \left( 1 + \sum_{j>k} f_{jk} + \sum_{j>k, l>m} f_{jk} f_{lm} + \dots \right) \end{aligned} \quad (2.25)$$

The first term simply gives a factor of the volume  $V$  for each integral, so we get  $V^N$ . The second term has a sum, each element of which is the same. They all look like

$$\int \prod_{i=1}^N d^3 r_i f_{12} = V^{N-2} \int d^3 r_1 d^3 r_2 f(r_{12}) = V^{N-1} \int d^3 r f(r)$$

where, in the last equality, we've simply changed integration variables from  $\vec{r}_1$  and  $\vec{r}_2$  to the centre of mass  $\vec{R} = \frac{1}{2}(\vec{r}_1 + \vec{r}_2)$  and the separation  $\vec{r} = \vec{r}_1 - \vec{r}_2$ . (You might worry that the limits of integration change in the integral over  $\vec{r}$ , but the integral over  $f(r)$  only picks up contributions from atomic size distances and this is only actually a problem close to the boundaries of the system where it is negligible). There is a term like this for each pair of particles – that is  $\frac{1}{2}N(N-1)$  such terms. For  $N \sim 10^{23}$ , we can just call this a round  $\frac{1}{2}N^2$ . Then, ignoring terms quadratic in  $f$  and higher, the partition function is approximately

$$\begin{aligned} Z(N, V, T) &= \frac{V^N}{N! \lambda^{3N}} \left( 1 + \frac{N^2}{2V} \int d^3 r f(r) + \dots \right) \\ &= Z_{\text{ideal}} \left( 1 + \frac{N}{2V} \int d^3 r f(r) + \dots \right)^N \end{aligned}$$



where we've used our previous result that  $Z_{\text{ideal}} = V^N/N!\lambda^{3N}$ . We've also engaged in something of a sleight of hand in this last line, promoting one power of  $N$  from in front of the integral to an overall exponent. Massaging the expression in this way ensures that the free energy is proportional to the number of particles as one would expect:

$$F = -k_B T \log Z = F_{\text{ideal}} - N k_B T \log \left( 1 + \frac{N}{2V} \int d^3r f(r) \right) \quad (2.26)$$

However, if you're uncomfortable with this little trick, it's not hard to convince yourself that the result (2.27) below for the equation of state doesn't depend on it. We will also look at the expansion more closely in the following section and see how all the higher order terms work out.

From the expression (2.26) for the free energy, it is clear that we are indeed performing an expansion in density of the gas since the correction term is proportional to  $N/V$ . This form of the free energy will give us the second virial coefficient  $B_2(T)$ .

We can be somewhat more precise about what it means to be at low density. The exact form of the integral  $\int d^3r f(r)$  depends on the potential, but for both the Lennard-Jones potential (2.22) and the hard-core repulsion (2.23), the integral is approximately  $\int d^3r f(r) \sim r_0^3$ , where  $r_0$  is roughly the minimum of the potential. (We'll compute the integral exactly below for the hard-core potential). For the expansion to be valid, we want each term with an extra power of  $f$  to be smaller than the preceding one. (This statement is actually only approximately true. We'll be more precise below when we develop the cluster expansion). That means that the second term in the argument of the log should be smaller than 1. In other words,

$$\frac{N}{V} \ll \frac{1}{r_0^3}$$

The left-hand side is the density of the gas. The right-hand side is atomic density. Or, equivalently, the density of a substance in which the atoms are packed closely together. But we have a name for such substances – we call them liquids! Our expansion is valid for densities of the gas that are much lower than that of the liquid state.

### 2.5.2 van der Waals Equation of State

We can use the free energy (2.26) to compute the pressure of the gas. Expanding the logarithm as  $\log(1+x) \approx x$  we get

$$p = -\frac{\partial F}{\partial V} = \frac{N k_B T}{V} \left( 1 - \frac{N}{2V} \int d^3r f(r) + \dots \right)$$

As expected, the pressure deviates from that of an ideal gas. We can characterize this by writing

$$\frac{pV}{Nk_B T} = 1 - \frac{N}{2V} \int d^3r f(r) \quad (2.27)$$

To understand what this is telling us, we need to compute  $\int d^3r f(r)$ . Firstly let's look at two trivial examples:

**Repulsion:** Suppose that  $U(r) > 0$  for all separations  $r$  with  $U(r = \infty) = 0$ . Then  $f = e^{-\beta U} - 1 < 0$  and the pressure increases, as we'd expect for a repulsive interaction.

**Attraction:** If  $U(r) < 0$ , we have  $f > 0$  and the pressure decreases, as we'd expect for an attractive interaction.

What about a more realistic interaction that is attractive at long distances and repulsive at short? We will compute the equation of state of a gas using the hard-core potential with van der Waals attraction (2.23). The integral of the Mayer  $f$  function is

$$\int d^3r f(r) = \int_0^{r_0} d^3r (-1) + \int_{r_0}^{\infty} d^3r (e^{+\beta U_0(r_0/r)^6} - 1) \quad (2.28)$$

We'll approximate the second integral in the high temperature limit,  $\beta U_0 \ll 1$ , where  $e^{+\beta U_0(r_0/r)^6} \approx 1 + \beta U_0(r_0/r)^6$ . Then

$$\begin{aligned} \int d^3r f(r) &= -4\pi \int_0^{r_0} dr r^2 + \frac{4\pi U_0}{k_B T} \int_{r_0}^{\infty} dr \frac{r_0^6}{r^4} \\ &= \frac{4\pi r_0^3}{3} \left( \frac{U_0}{k_B T} - 1 \right) \end{aligned} \quad (2.29)$$

Inserting this into (2.27) gives us an expression for the equation of state,

$$\frac{pV}{Nk_B T} = 1 - \frac{N}{V} \left( \frac{a}{k_B T} - b \right)$$

We recognise this expansion as capturing the second virial coefficient in (2.21) as promised. The constants  $a$  and  $b$  are defined by

$$a = \frac{2\pi r_0^3 U_0}{3}, \quad b = \frac{2\pi r_0^3}{3}$$

It is actually slightly more useful to write this in the form  $k_B T = \dots$ . We can multiply through by  $k_B T$  then, rearranging we have

$$k_B T = \frac{V}{N} \left( p + \frac{N^2}{V^2} a \right) \left( 1 + \frac{N}{V} b \right)^{-1}$$

Since we're working in an expansion in density,  $N/V$ , we're at liberty to Taylor expand the last bracket, keeping only the first two terms. We get

$$k_B T = \left( p + \frac{N^2}{V^2} a \right) \left( \frac{V}{N} - b \right) \quad (2.30)$$

This is the famous *van der Waals equation of state* for a gas. We stress again the limitations of our analysis: it is valid only at low densities and (because of our approximation when performing the integral (2.28)) at high temperatures.

We will return to the van der Waals equation in Section 5 where we'll explore many of its interesting features. For now, we can get a feeling for the physics behind this equation of state by rewriting it in yet another way,

$$p = \frac{N k_B T}{V - bN} - a \frac{N^2}{V^2} \quad (2.31)$$

The constant  $a$  contains a factor of  $U_0$  and so captures the effect of the attractive interaction at large distances. We see that its role is to reduce the pressure of the gas. The reduction in pressure is proportional to the density squared because this is, in turn, proportional to the number of *pairs* of particles which feel the attractive force. In contrast,  $b$  only contains  $r_0$  and arises due to the hard-core repulsion in the potential. Its effect is to reduce the effective volume of the gas because of the space taken up by the particles.

It is worth pointing out where some quizzical factors of two come from in  $b = 2\pi r_0^3/3$ . Recall that  $r_0$  is the minimum distance that two atoms can approach. If we think of each atom as a hard sphere, then they have radius  $r_0/2$  and volume  $4\pi(r_0/2)^3/3$ . Which isn't equal to  $b$ . However, as illustrated in the figure, the excluded volume around each atom is actually  $\Omega = 4\pi r_0^3/3 = 2b$ . So why don't we have  $\Omega$  sitting in the denominator of the van der Waals equation rather than  $b = \Omega/2$ ? Think about adding the atoms one at a time. The first guy can move in volume  $V$ ; the second in volume  $V - \Omega$ ; the third in volume  $V - 2\Omega$  and so on. For  $\Omega \ll V$ , the total configuration space available to the atoms is

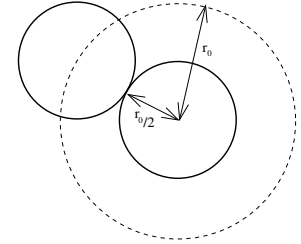

**Figure 13:**

$$\frac{1}{N!} \prod_{m=1}^N (V - m\Omega) \approx \frac{V^N}{N!} \left( 1 - \frac{N^2 \Omega}{2V} + \dots \right) \approx \frac{1}{N!} \left( V - \frac{N\Omega}{2} \right)^N$$

And there's that tricky factor of  $1/2$ .

Above we computed the equation of state for the dipole van der Waals interaction with hard core potential. But our expression (2.27) can seemingly be used to compute the equation of state for any potential between atoms. However, there are limitations. Looking back to the integral (2.29), we see that a long-range force of the form  $1/r^n$  will only give rise to a convergent integral for  $n \geq 4$ . This means that the techniques described above do not work for *long-range* potentials with fall-off  $1/r^3$  or slower. This includes the important case of  $1/r$  Coulomb interactions.

### 2.5.3 The Cluster Expansion

Above we computed the leading order correction to the ideal gas law. In terms of the virial expansion (2.21) this corresponds to the second virial coefficient  $B_2$ . We will now develop the full expansion and explain how to compute the higher virial coefficients.

Let's go back to equation (2.25) where we first expressed the partition function in terms of  $f$ ,

$$\begin{aligned} Z(N, V, T) &= \frac{1}{N! \lambda^{3N}} \int \prod_i d^3 r_i \prod_{j>k} (1 + f_{jk}) \\ &= \frac{1}{N! \lambda^{3N}} \int \prod_i d^3 r_i \left( 1 + \sum_{j>k} f_{jk} + \sum_{j>k, l>m} f_{jk} f_{lm} + \dots \right) \end{aligned} \quad (2.32)$$

Above we effectively related the second virial coefficient to the term linear in  $f$ : this is the essence of the equation of state (2.27). One might think that terms quadratic in  $f$  give rise to the third virial coefficient and so on. But, as we'll now see, the expansion is somewhat more subtle than that.

The expansion in (2.32) includes terms of the form  $f_{ij} f_{kl} f_{mn} \dots$  where the indices denote pairs of atoms,  $(i, j)$  and  $(k, l)$  and so on. These pairs may have atoms in common or they may all be different. However, the same pair never appears twice in a given term as you may check by going back to the first line in (2.32). We'll introduce a diagrammatic method to keep track of all the terms in the sum. To each term of the form  $f_{ij} f_{kl} f_{mn} \dots$  we associate a picture using the following rules

- Draw  $N$  atoms. (This gets tedious for  $N \sim 10^{23}$  but, as we'll soon see, we will actually only need pictures with small subset of atoms).
- Draw a line between each pair of atoms that appear as indices. So for  $f_{ij} f_{kl} f_{mn} \dots$ , we draw a line between atom  $i$  and atom  $j$ ; a line between atom  $k$  and atom  $l$ ; and so on.

For example, if we have just  $N = 4$ , we have the following pictures for different terms in the expansion,

$$f_{12} = \begin{array}{c} \bullet \quad \bullet \\ 3 \quad 4 \\ \hline \bullet \quad \bullet \\ 1 \quad 2 \end{array} \quad f_{12}f_{34} = \begin{array}{c} \bullet \quad \bullet \\ 3 \quad 4 \\ \hline \bullet \quad \bullet \\ 1 \quad 2 \end{array} \quad f_{12}f_{23} = \begin{array}{c} \bullet \quad \bullet \\ 3 \quad 4 \\ \diagdown \quad \diagup \\ \bullet \quad \bullet \\ 1 \quad 2 \end{array} \quad f_{21}f_{23}f_{31} = \begin{array}{c} \bullet \quad \bullet \\ 3 \quad 4 \\ \diagdown \quad \diagup \\ \bullet \quad \bullet \\ 1 \quad 2 \end{array}$$

We call these diagrams *graphs*. Each possible graph appears exactly once in the partition function (2.32). In other words, the partition function is a sum over all graphs. We still have to do the integrals over all positions  $\vec{r}_i$ . We will denote the integral over graph  $G$  to be  $W[G]$ . Then the partition function is

$$Z(N, V, T) = \frac{1}{N! \lambda^{3N}} \sum_G W[G]$$

Nearly all the graphs that we can draw will have disconnected components. For example, those graphs that correspond to just a single  $f_{ij}$  will have two atoms connected and the remaining  $N - 2$  sitting alone. Those graphs that correspond to  $f_{ij}f_{kl}$  fall into two categories: either they consist of two pairs of atoms (like the second example above) or, if  $(i, j)$  shares an atom with  $(k, l)$ , there are three linked atoms (like the third example above). Importantly, the integral over positions  $\vec{r}_i$  then factorises into a product of integrals over the positions of atoms in disconnected components. This is illustrated by an example with  $N = 5$  atoms,

$$W \left[ \begin{array}{c} \bullet \quad \bullet \\ 3 \quad 4 \\ \diagdown \quad \diagup \\ \bullet \quad \bullet \\ 1 \quad 2 \end{array} \quad \begin{array}{c} \bullet \\ 4 \\ \hline \bullet \\ 5 \end{array} \right] = \left( \int d^3r_1 d^3r_2 d^3r_3 f_{12} f_{23} f_{31} \right) \left( \int d^3r_4 d^3r_5 f_{45} \right)$$

We call the disconnected components of the graph *clusters*. If a cluster has  $l$  atoms, we will call it an  $l$ -cluster. The  $N = 5$  example above has a single 3-cluster and a single 2-cluster. In general, a graph  $G$  will split into  $m_l$   $l$ -clusters. Clearly, we must have

$$\sum_{l=1}^N m_l l = N \tag{2.33}$$

Of course, for a graph with only a few lines and lots of atoms, nearly all the atoms will be in lonely 1-clusters.

We can now make good on the promise above that we won't have to draw all  $N \sim 10^{23}$  atoms. The key idea is that we can focus on clusters of  $l$ -atoms. We will organise the expansion in such a way that the  $(l + 1)$ -clusters are less important than the  $l$ -clusters.

To see how this works, let's focus on 3-clusters for now. There are four different ways that we can have a 3-cluster,

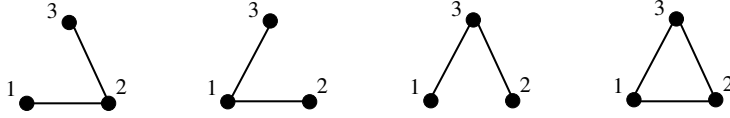

Each of these 3-clusters will appear in a graph with any other combination of clusters among the remaining  $N-3$  atoms. But since clusters factorise in the partition function, we know that  $Z$  must include a factor

$$U_3 \equiv \int d^3r_1 d^3r_2 d^3r_3 \left( \begin{array}{c} 3 \\ \cdot \\ \diagdown \\ \cdot \\ 1 \quad 2 \end{array} + \begin{array}{c} 3 \\ \cdot \\ \diagup \\ \cdot \\ 1 \quad 2 \end{array} + \begin{array}{c} 3 \\ \cdot \\ \diagup \quad \diagdown \\ \cdot \\ 1 \quad 2 \end{array} + \begin{array}{c} 3 \\ \cdot \\ \diagup \quad \diagdown \\ \cdot \\ 1 \quad 2 \end{array} \right)$$

$U_3$  contains terms of order  $f^2$  and  $f^3$ . It turns out that this is the correct way to arrange the expansion: not in terms of the number of lines in the diagram, which is equal to the power of  $f$ , but instead in terms of the number of atoms that they connect. The partition function will similarly contain factors associated to all other  $l$ -clusters. We define the corresponding integrals as

$$U_l \equiv \int \prod_{i=1}^l d^3r_i \sum_{G \in \{l\text{-cluster}\}} G \quad (2.34)$$

Notice that  $U_1$  is simply the integral over space, namely  $U_1 = V$ . The full partition function must be a product of  $U_l$ 's. The tricky part is to get all the combinatoric factors right to make sure that you count each graph exactly once. This is the way it works: the number of graphs with  $m_l$   $l$ -clusters is

$$\frac{N!}{\prod_l (l!)^{m_l}}$$

where the numerator  $N!$  counts the permutation of all particles while the denominator counts the ways we can permute particles within a cluster. However, if we have  $m_l > 1$  clusters of a given size then we can also permute these factors among themselves. The end result is that the sum over graphs  $G$  that appears in the partition function is

$$\sum_G W[G] = \sum_{\{m_l\}} \prod_l \frac{N!}{(l!)^{m_l}} \left( \frac{U_l^{m_l}}{m_l!} \right) \quad (2.35)$$

Combinatoric arguments are not always transparent. Let's do a couple of checks to make sure that this is indeed the right answer. Firstly, consider  $N = 4$  atoms split into two 2-clusters (i.e  $m_2 = 2$ ). There are three such diagrams,  $f_{12}f_{34} = \begin{array}{c} \cdot \quad \cdot \\ \hline \cdot \quad \cdot \end{array}$ ,  $f_{13}f_{24} = \begin{array}{c} \cdot \quad \cdot \\ \cdot \quad \cdot \end{array}$ , and  $f_{14}f_{23} = \begin{array}{c} \cdot \quad \cdot \\ \diagdown \quad \diagup \\ \cdot \quad \cdot \end{array}$ . Each of these gives the same answer when integrated, namely  $U_2^2$  so the final result should be  $3U_2^2$ . We can check this against the relevant terms in (2.35) which are  $4!U_2^2/2!^22! = 3U_2^2$  as expected.

Another check:  $N = 5$  atoms with  $m_2 = m_3 = 1$ . All diagrams come in the combinations

$$U_3 U_2 = \int \prod_{i=1}^5 d^3 r_i \left( \begin{array}{c} \bullet \\ \diagdown \\ \bullet \end{array} \begin{array}{c} \bullet \\ | \\ \bullet \end{array} + \begin{array}{c} \bullet \\ | \\ \bullet \end{array} \begin{array}{c} \bullet \\ \diagdown \\ \bullet \end{array} + \begin{array}{c} \bullet \\ \diagup \\ \bullet \end{array} \begin{array}{c} \bullet \\ | \\ \bullet \end{array} + \begin{array}{c} \bullet \\ \diagdown \\ \bullet \end{array} \begin{array}{c} \bullet \\ \diagup \\ \bullet \end{array} \begin{array}{c} \bullet \\ | \\ \bullet \end{array} \right)$$

together with graphs that are related by permutations. The permutations are fully determined by the choice of the two atoms that sit in the pair: there are 10 such choices. The answer should therefore be  $10U_3U_2$ . Comparing to (2.35), we have  $5!U_3U_2/3!2! = 10U_3U_2$  as required.

Hopefully you are now convinced that (2.35) counts the graphs correctly. The end result for the partition function is therefore

$$Z(N, V, T) = \frac{1}{\lambda^{3N}} \sum_{\{m_l\}} \prod_l \frac{U_l^{m_l}}{(l!)^{m_l} m_l!}$$

The problem with computing this sum is that we still have to work out the different ways that we can split  $N$  atoms into different clusters. In other words, we still have to obey the constraint (2.33). Life would be very much easier if we didn't have to worry about this. Then we could just sum over any  $m_l$ , regardless. Thankfully, this is exactly what we can do if we work in the grand canonical ensemble where  $N$  is not fixed! The grand canonical ensemble is

$$\mathcal{Z}(\mu, V, T) = \sum_N e^{\beta\mu N} Z(N, V, T)$$

We define the *fugacity* as  $z = e^{\beta\mu}$ . Then we can write

$$\begin{aligned} \mathcal{Z}(\mu, V, T) &= \sum_N z^N Z(N, V, T) \\ &= \sum_{m_l=0}^{\infty} \prod_{l=1}^{\infty} \left( \frac{z}{\lambda^3} \right)^{m_l l} \frac{1}{m_l!} \left( \frac{U_l}{l!} \right)^{m_l} \\ &= \prod_{l=1}^{\infty} \exp \left( \frac{U_l z^l}{\lambda^{3l} l!} \right) \end{aligned}$$

One usually defines

$$b_l = \frac{\lambda^3}{V} \frac{U_l}{l! \lambda^{3l}} \tag{2.36}$$

Notice in particular that  $U_1 = V$  so this definition gives  $b_1 = 1$ . Then we can write the grand partition function as

$$\mathcal{Z}(\mu, V, T) = \prod_{l=1}^{\infty} \exp\left(\frac{V}{\lambda^3} b_l z^l\right) = \exp\left(\frac{V}{\lambda^3} \sum_{l=1}^{\infty} b_l z^l\right) \quad (2.37)$$

Something rather cute happened here. The sum over all diagrams got rewritten as the exponential over the sum of all *connected* diagrams, meaning all clusters. This is a general lesson which also carries over to quantum field theory where the diagrams in question are Feynman diagrams.

Back to the main plot of our story, we can now compute the pressure

$$\frac{pV}{k_B T} = \log \mathcal{Z} = \frac{V}{\lambda^3} \sum_{l=1}^{\infty} b_l z^l$$

and the number of particles

$$\frac{N}{V} = \frac{z}{V} \frac{\partial}{\partial z} \log \mathcal{Z} = \frac{1}{\lambda^3} \sum_{l=1}^{\infty} l b_l z^l \quad (2.38)$$

Dividing the two gives us the equation of state,

$$\frac{pV}{Nk_B T} = \frac{\sum_l b_l z^l}{\sum_l l b_l z^l} \quad (2.39)$$

The only downside is that the equation of state is expressed in terms of  $z$ . To massage it into the form of the virial expansion (2.21), we need to invert (2.38) to get  $z$  in terms of the particle density  $N/V$ . Equating (2.39) with (2.21) (and defining  $B_1 = 1$ ), we have

$$\begin{aligned} \sum_{l=1}^{\infty} b_l z^l &= \sum_{l=1}^{\infty} B_l \left(\frac{N}{V}\right)^{l-1} \sum_{m=1}^{\infty} m b_m z^m \\ &= \sum_{l=1}^{\infty} \frac{B_l}{\lambda^{3(l-1)}} \left(\sum_{n=1}^{\infty} n b_n z^n\right)^{l-1} \sum_{m=1}^{\infty} m b_m z^m \\ &= \left[ 1 + \frac{B_2}{\lambda^3} (z + 2b_2 z^2 + 3b_3 z^3 + \dots) + \frac{B_3}{\lambda^6} (z + 2b_2 z^2 + 3b_3 z^3 + \dots)^2 + \dots \right] \\ &\quad \times [z + 2b_2 z^2 + 3b_3 z^3 + \dots] \end{aligned}$$

where we've used both  $B_1 = 1$  and  $b_1 = 1$ . Expanding out the left- and right-hand sides to order  $z^3$  gives

$$z + b_2 z^2 + b_3 z^3 + \dots = z + \left(\frac{B_2}{\lambda^3} + 2b_2\right) z^2 + \left(3b_3 + \frac{4b_2 B_2}{\lambda^3} + \frac{B_3}{\lambda^3}\right) z^3 + \dots$$



Comparing terms, and recollecting the definitions of  $b_l$  (2.36) in terms of  $U_l$  (2.34) in terms of graphs, we find the second virial coefficient is given by

$$B_2 = -\lambda^3 b_2 = -\frac{U_2}{2V} = -\frac{1}{2V} \int d^3r_1 d^3r_2 f(\vec{r}_1 - \vec{r}_2) = -\frac{1}{2} \int d^3r f(r)$$

which reproduces the result (2.27) that we found earlier using slightly simpler methods. We now also have an expression for the third coefficient,

$$B_3 = \lambda^6 (4b_2^2 - 2b_3)$$

although admittedly we still have a nasty integral to do before we have a concrete result. More importantly, the cluster expansion gives us the technology to perform a systematic perturbation expansion to any order we wish.

## 2.6 Screening and the Debye-Hückel Model of a Plasma

There are many other applications of the classical statistical methods that we saw in this chapter. Here we use them to derive the important phenomenon of *screening*. The problem we will consider, which sometimes goes by the name of a “one-component plasma”, is the following: a gas of electrons, each with charge  $-q$ , moves in a fixed background of uniform positive charge density  $+q\rho$ . The charge density is such that the overall system is neutral which means that  $\rho$  is also the average charge density of the electrons. This is the Debye-Hückel model.

In the absence of the background charge density, the interaction between electrons is given by the Coulomb potential

$$U(r) = \frac{q^2}{r}$$

where we’re using units in which  $4\pi\epsilon_0 = 1$ . How does the fixed background charge affect the potential between electrons? The clever trick of the Debye-Hückel model is to use statistical methods to figure out the answer to this question. Consider placing one electron at the origin. Let’s try to work out the electrostatic potential  $\phi(\vec{r})$  due to this electron. It is not obvious how to do this because  $\phi$  will also depend on the positions of all the other electrons. In general we can write,

$$\nabla^2 \phi(\vec{r}) = -4\pi (-q\delta(\vec{r}) + q\rho - q\rho g(\vec{r})) \quad (2.40)$$

where the first term on the right-hand side is due to the electron at the origin; the second term is due to the background positive charge density; and the third term is due to the other electrons whose average charge density close to the first electron is

$\rho g(\vec{r})$ . The trouble is that we don't know the function  $g$ . If we were sitting at zero temperature, the electrons would try to move apart as much as possible. But at non-zero temperatures, their thermal energy will allow them to approach each other. This is the clue that we need. The energy cost for an electron to approach the origin is, of course,  $E(\vec{r}) = -q\phi(\vec{r})$ . We will therefore assume that the charge density near the origin is given by the Boltzmann factor,

$$g(\vec{r}) \approx e^{\beta q\phi(\vec{r})}$$

For high temperatures,  $\beta q\phi \ll 1$ , we can write  $e^{\beta q\phi} \approx 1 + \beta q\phi$  and the Poisson equation (2.40) becomes

$$\left(\nabla^2 + \frac{1}{\lambda_D^2}\right)\phi(\vec{r}) = 4\pi q\delta(\vec{r})$$

where  $\lambda_D^2 = 1/4\pi\beta\rho q^2$ . This equation has the solution,

$$\phi(\vec{r}) = -\frac{qe^{-r/\lambda_D}}{r} \tag{2.41}$$

which immediately translates into an effective potential energy between electrons,

$$U_{\text{eff}}(r) = \frac{q^2 e^{-r/\lambda_D}}{r}$$

We now see that the effect of the plasma is to introduce the exponential factor in the numerator, causing the potential to decay very quickly at distances  $r > \lambda_D$ . This effect is called *screening* and  $\lambda_D$  is known as the *Debye screening length*. The derivation of (2.41) is self-consistent if we have a large number of electrons within a distance  $\lambda_D$  of the origin so that we can happily talk about average charge density. This means that we need  $\rho\lambda_D^3 \gg 1$ .

### 3. Quantum Gases

In this section we will discuss situations where quantum effects are important. We'll still restrict attention to gases — meaning a bunch of particles moving around and barely interacting — but one of the first things we'll see is how versatile the idea of a gas can be in the quantum world. We'll use it to understand not just the traditional gases that we met in the previous section but also light and, ironically, certain properties of solids. In the latter part of this section, we will look at what happens to gases at low temperatures where their behaviour is dominated by quantum statistics.

#### 3.1 Density of States

We start by introducing the important concept of the density of states. To illustrate this, we'll return once again to the ideal gas trapped in a box with sides of length  $L$  and volume  $V = L^3$ . Viewed quantum mechanically, each particle is described by a wavefunction. We'll impose periodic boundary conditions on this wavefunction (although none of the physics that we'll discuss in this course will be sensitive to the choice of boundary condition). If there are no interactions between particles, the energy eigenstates are simply plane waves,

$$\psi = \frac{1}{\sqrt{V}} e^{i\vec{k}\cdot\vec{x}}$$

Boundary conditions require that the wavevector  $\vec{k} = (k_1, k_2, k_3)$  is quantized as

$$k_i = \frac{2\pi n_i}{L} \quad \text{with } n_i \in \mathbf{Z}$$

and the energy of the particle is

$$E_{\vec{n}} = \frac{\hbar^2 k^2}{2m} = \frac{4\pi^2 \hbar^2}{2mL^2} (n_1^2 + n_2^2 + n_3^2)$$

with  $k = |\vec{k}|$ . The quantum mechanical single particle partition function (1.21) is given by the sum over all energy eigenstates,

$$Z_1 = \sum_{\vec{n}} e^{-\beta E_{\vec{n}}}$$

The question is: how do we do the sum? The simplest way is to approximate it by an integral. Recall from the previous section that the thermal wavelength of the particle is defined to be

$$\lambda = \sqrt{\frac{2\pi\hbar^2}{mk_B T}}$$

The exponents that appear in the sum are all of the form  $\sim \lambda^2 n^2 / L^2$ , up to some constant factors. For any macroscopic size box,  $\lambda \ll L$  (a serious understatement! Actually  $\lambda \lll L$ ) which ensures that there are many states with  $E_{\vec{n}} \leq k_B T$  all of which contribute to the sum. (There will be an exception to this at very low temperatures which will be the focus of Section 3.5.3). We therefore lose very little by approximating the sum by an integral. We can write the measure of this integral as

$$\sum_{\vec{n}} \approx \int d^3 n = \frac{V}{(2\pi)^3} \int d^3 k = \frac{4\pi V}{(2\pi)^3} \int_0^\infty dk k^2$$

where, in the last equality, we have integrated over the angular directions to get  $4\pi$ , the area of the 2-sphere, leaving an integration over the magnitude  $k = |\vec{k}|$  and the Jacobian factor  $k^2$ . For future applications, it will prove more useful to change integration variables at this stage. We work instead with the energy,

$$E = \frac{\hbar^2 k^2}{2m} \quad \Rightarrow \quad dE = \frac{\hbar^2 k}{m} dk$$

We can now write out integral as

$$\frac{4\pi V}{(2\pi)^3} \int dk k^2 = \frac{V}{2\pi^2} \int dE \sqrt{\frac{2mE}{\hbar^2}} \frac{m}{\hbar^2} \equiv \int dE g(E) \quad (3.1)$$

where

$$g(E) = \frac{V}{4\pi^2} \left( \frac{2m}{\hbar^2} \right)^{3/2} E^{1/2} \quad (3.2)$$

is the *density of states*:  $g(E)dE$  counts the number of states with energy between  $E$  and  $E + dE$ . Notice that we haven't actually done the integral over  $E$  in (3.1); instead this is to be viewed as a measure which we can integrate over any function  $f(E)$  of our choosing.

There is nothing particularly quantum mechanical about the density of states. Indeed, in the derivation above we have replaced the quantum sum with an integral over momenta which actually looks rather classical. Nonetheless, as we encounter more and more different types of gases, we'll see that the density of states appears in all the calculations and it is a useful quantity to have at our disposal.

### 3.1.1 Relativistic Systems

Relativistic particles moving in  $d = 3 + 1$  spacetime dimensions have kinetic energy

$$E = \sqrt{\hbar^2 k^2 c^2 + m^2 c^4} \quad (3.3)$$

Repeating the steps above, we find the density of states is given by

$$g(E) = \frac{VE}{2\pi^2\hbar^3c^3} \sqrt{E^2 - m^2c^4} \quad (3.4)$$

In particular, for massless particles, the density of states is

$$g(E) = \frac{VE^2}{2\pi^2\hbar^3c^3} \quad (3.5)$$

### 3.2 Photons: Blackbody Radiation

“It was an act of desperation. For six years I had struggled with the blackbody theory. I knew the problem was fundamental and I knew the answer. I had to find a theoretical explanation at any cost, except for the inviolability of the two laws of thermodynamics”

*Max Planck*

We now turn to our first truly quantum gas: light. We will consider a gas of photons — the quanta of the electromagnetic field — and determine a number of its properties, including the distribution of wavelengths. Or, in other words, its colour.

Below we will describe the colour of light at a fixed temperature. But this also applies (with a caveat) to the colour of any object at the same temperature. The argument for this is as follows: consider bathing the object inside the gas of photons. In equilibrium, the object sits at the same temperature as the photons, emitting as many photons as it absorbs. The colour of the object will therefore mimic that of the surrounding light.

For a topic that’s all about colour, a gas of photons is usually given a rather bland name — *blackbody radiation*. The reason for this is that any real object will exhibit absorption and emission lines due to its particular atomic make-up (this is the caveat mentioned above). We’re not interested in these details; we only wish to compute the spectrum of photons that a body emits because it’s hot. For this reason, one sometimes talks about an idealised body that absorbs photons of any wavelength and reflects none. At zero temperature, such an object would appear black: this is the blackbody of the title. We would like to understand its colour as we turn up the heat.

To begin, we need some facts about photons. The energy of a photon is determined by its wavelength  $\lambda$  or, equivalently, by its frequency  $\omega = 2\pi c/\lambda$  to be

$$E = \hbar\omega$$

This is a special case of the relativistic energy formula (3.3) for massless particles,  $m = 0$ . The frequency is related to the (magnitude of the) wavevector by  $\omega = kc$ .

Photons have two polarization states (one for each dimension transverse to the direction of propagation). To account for this, the density of states (3.5) should be multiplied by a factor of two. The number of states available to a single photon with energy between  $E$  and  $E + dE$  is therefore

$$g(E)dE = \frac{VE^2}{\pi^2\hbar^3c^3}dE$$

Equivalently, the number of states available to a single photon with frequency between  $\omega$  and  $\omega + d\omega$  is

$$g(E)dE = g(\omega)d\omega = \frac{V\omega^2}{\pi^2c^3}d\omega \quad (3.6)$$

where we've indulged in a slight abuse of notation since  $g(\omega)$  is not the same function as  $g(E)$  but is instead defined by the equation above. It is also worth pointing out an easy mistake to make when performing these kinds of manipulations with densities of states: you need to remember to rescale the interval  $dE$  to  $d\omega$ . This is most simply achieved by writing  $g(E)dE = g(\omega)d\omega$  as we have above. If you miss this then you'll get  $g(\omega)$  wrong by a factor of  $\hbar$ .

The final fact that we need is important: photons are not conserved. If you put six atoms in a box then they will still be there when you come back a month later. This isn't true for photons. There's no reason that the walls of the box can't absorb one photon and then emit two. The number of photons in the world is not fixed. To demonstrate this, you simply need to turn off the light.

Because photon number is not conserved, we're unable to define a chemical potential for photons. Indeed, even in the canonical ensemble we must already sum over states with different numbers of photons because these are all "accessible states". (It is sometimes stated that we should work in the grand canonical ensemble at  $\mu = 0$  which is basically the same thing). This means that we should consider states with any number  $N$  of photons.

We'll start by looking at photons with a definite frequency  $\omega$ . A state with  $N$  such photons has energy  $E = N\hbar\omega$ . Summing over all  $N$  gives us the partition function for photons at fixed frequency,

$$Z_\omega = 1 + e^{-\beta\hbar\omega} + e^{-2\beta\hbar\omega} + \dots = \frac{1}{1 - e^{-\beta\hbar\omega}} \quad (3.7)$$

We now need to sum over all possible frequencies. As we've seen a number of times, independent partition functions multiply, which means that the logs add. We only need

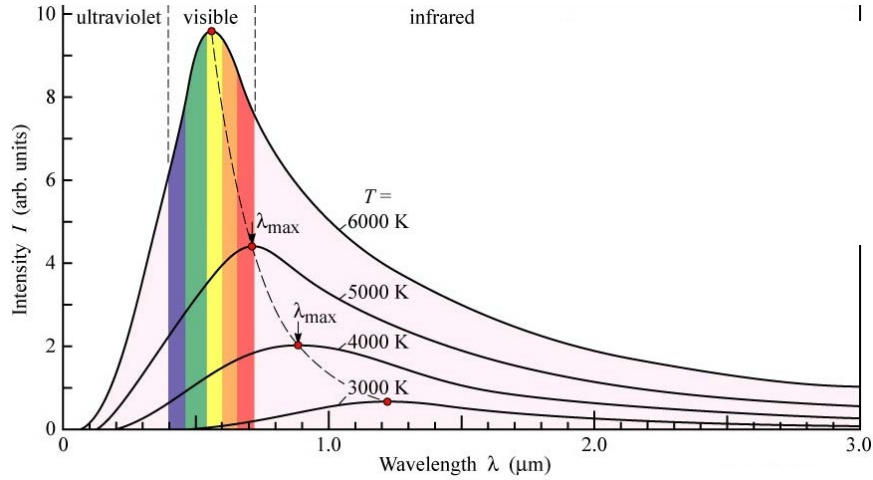

**Figure 14:** The Planck Distribution function (Source: E. Schubert, *Light Emitting Diodes*).

to know how many photon states there are with some frequency  $\omega$ . But this is what the density of states (3.6) tells us. We have

$$\log Z = \int_0^\infty d\omega g(\omega) \log Z_\omega = -\frac{V}{\pi^2 c^3} \int_0^\infty d\omega \omega^2 \log(1 - e^{-\beta\hbar\omega}) \quad (3.8)$$

### 3.2.1 Planck Distribution

From the partition function (3.8) we can calculate all interesting quantities for a gas of light. For example, the energy density stored in the photon gas is

$$E = -\frac{\partial}{\partial\beta} \log Z = \frac{V\hbar}{\pi^2 c^3} \int_0^\infty d\omega \frac{\omega^3}{e^{\beta\hbar\omega} - 1} \quad (3.9)$$

However, before we do the integral over frequency, there's some important information contained in the integrand itself: it tells us the amount of energy carried by photons with frequency between  $\omega$  and  $\omega + d\omega$

$$E(\omega)d\omega = \frac{V\hbar}{\pi^2 c^3} \frac{\omega^3}{e^{\beta\hbar\omega} - 1} d\omega \quad (3.10)$$

This is the *Planck distribution*. It is plotted above for various temperatures. As you can see from the graph, for hot gases the maximum in the distribution occurs at a lower wavelength or, equivalently, at a higher frequency. We can easily determine where this maximum occurs by finding the solution to  $dE(\omega)/d\omega = 0$ . It is

$$\omega_{\max} = \zeta \frac{k_B T}{\hbar}$$

where  $\zeta \approx 2.822$  solves  $3 - \zeta = 3e^{-\zeta}$ . The equation above is often called *Wien's displacement law*. Roughly speaking, it tells you the colour of a hot object.

To compute the total energy in the gas of photons, we need to do the integration in (3.9). To highlight how the total energy depends on temperature, it is useful to perform the rescaling  $x = \beta\hbar\omega$ , to get

$$E = \frac{V}{\pi^2 c^3} \frac{(k_B T)^4}{\hbar^3} \int_0^\infty \frac{x^3 dx}{e^x - 1}$$

The integral  $I = \int dx x^3/(e^x - 1)$  is tricky but doable. It turns out to be  $I = \pi^4/15$ . (We will effectively prove this fact later in the course when we consider a more general class of integrals (3.27) which can be manipulated into the sum (3.28). The net result of this is to express the integral  $I$  above in terms of the Gamma function and the Riemann zeta function:  $I = \Gamma(4)\zeta(4) = \pi^4/15$ ). We learn that the energy density  $\mathcal{E} = E/V$  in a gas of photons scales is proportional to  $T^4$ ,

$$\mathcal{E} = \frac{\pi^2 k_B^4}{15 \hbar^3 c^3} T^4$$

### Stefan-Boltzmann Law

The expression for the energy density above is closely related to the *Stefan-Boltzmann law* which describes the energy emitted by an object at temperature  $T$ . That energy flux is defined as the rate of transfer of energy from the surface per unit area. It is given by

$$\text{Energy Flux} = \frac{\mathcal{E}c}{4} \equiv \sigma T^4 \quad (3.11)$$

where

$$\sigma = \frac{\pi^2 k_B^4}{60 \hbar^3 c^2} = 5.67 \times 10^{-8} \text{ Js}^{-1} \text{ m}^{-2} \text{ K}^{-4}$$

is the Stefan constant.

The factor of the speed of light in the middle equation of (3.11) appears because the flux is the *rate* of transfer of energy. The factor of 1/4 comes because we're not considering the flux emitted by a point source, but rather by an actual object whose size is bigger than the wavelength of individual photons. This means that the photons are only emitted in one direction: away from the object, not into it. Moreover, we only care about the velocity perpendicular to the object, which is  $(c \cos \theta)$  where  $\theta$  is the angle the photon makes with the normal. This means that rather than filling out a sphere of area  $4\pi$  surrounding the object, the actual flux of photons from any point on the object's surface is given by

$$\frac{1}{4\pi} \int_0^{2\pi} d\phi \int_0^{\pi/2} d\theta \sin \theta (c \cos \theta) = \frac{c}{4}$$



## Radiation Pressure and Other Stuff

All other quantities of interest can be computed from the free energy,

$$\begin{aligned} F &= -k_B T \log Z \\ &= \frac{V k_B T}{\pi^2 c^3} \int_0^\infty d\omega \omega^2 \log(1 - e^{-\beta \hbar \omega}) \end{aligned}$$

We can remove the logarithm through an integration by parts to get,

$$\begin{aligned} F &= -\frac{V \hbar}{3\pi^2 c^3} \int_0^\infty d\omega \frac{\omega^3 e^{-\beta \hbar \omega}}{1 - e^{-\beta \hbar \omega}} \\ &= -\frac{V \hbar}{3\pi^2 c^3} \frac{1}{\beta^4 \hbar^4} \int_0^\infty dx \frac{x^3}{e^x - 1} \\ &= -\frac{V \pi^2}{45 \hbar^3 c^3} (k_B T)^4 \end{aligned}$$

From this we can compute the pressure due to electromagnetic radiation,

$$p = - \left. \frac{\partial F}{\partial V} \right|_T = \frac{E}{3V} = \frac{4\sigma}{3c} T^4$$

This is the equation of state for a gas of photons. The middle equation tells us that the pressure of photons is one third of the energy density — a fact which will be important in the *Cosmology* course.

We can also calculate the entropy  $S$  and heat capacity  $C_V$ . They are both most conveniently expressed in terms of the Stefan constant which hides most of the annoying factors,

$$S = - \left. \frac{\partial F}{\partial T} \right|_V = \frac{16V\sigma}{3c} T^3 \quad , \quad C_V = \left. \frac{\partial E}{\partial T} \right|_V = \frac{16V\sigma}{c} T^3$$

### 3.2.2 The Cosmic Microwave Background Radiation

The cosmic microwave background, or CMB, is the afterglow of the big bang, a uniform light that fills the Universe. The intensity of this light was measured accurately by the FIRAS (far infrared absolute spectrophotometer) instrument on the COBE satellite in the early 1990s. The result is shown on the right, together with the theoretical curve for a blackbody spectrum at  $T = 2.725 \text{ K}$ . It may look as if the error bars are large, but this is only because they have been multiplied by a factor of 400. If the error bars were drawn at the correct size, you wouldn't be able to see them.

This result is totally astonishing. The light has been traveling for 13.7 billion years, almost since the beginning of time itself. And yet we can understand it with ridiculous accuracy using such a simple calculation. If you're not awed by this graph then you have no soul.

If you peer closely enough, the data does depart from the blackbody curve. You need to measure to an accuracy of one part in  $10^5$ . That's where the story gets really interesting. But it's a topic for another course.

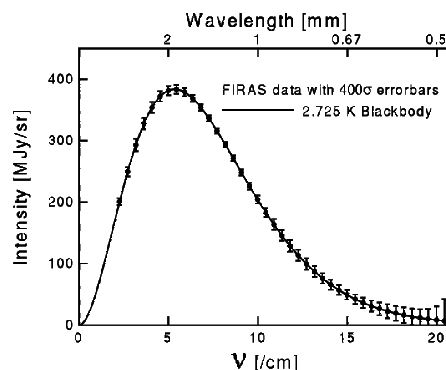

**Figure 15:**

### 3.2.3 The Birth of Quantum Mechanics

The key conceptual input in the derivation of Planck's formula (3.10) is that light of frequency  $\omega$  comes in packets of energy  $E = \hbar\omega$ . Historically, this was the first time that the idea of quanta arose in theoretical physics.

Let's see what would happen in a classical world where light of frequency  $\omega$  can have arbitrarily low intensity and, correspondingly, arbitrarily low energy. This is effectively what happens in the regime  $\hbar\omega \ll k_B T$  of the Planck distribution where the minimum energy  $\hbar\omega$  is completely swamped by the temperature. There we can approximate

$$\frac{1}{e^{\beta\hbar\omega} - 1} \approx \frac{1}{\beta\hbar\omega}$$

and Planck's distribution formula (3.10) reduces to

$$E(\omega) = \frac{V}{2\pi^2 c^3} \omega^2 k_B T$$

Notice that all hints of the quantum  $\hbar$  have vanished. This is the *Rayleigh-Jeans law* for the distribution of classical radiation. It has a serious problem if we try to extrapolate it to high frequencies since the total energy,  $E = \int_0^\infty E(\omega) d\omega$ , diverges. This was referred to as the ultra-violet catastrophe. In contrast, in Planck's formula (3.10) there is an exponential suppression at high frequencies. This arises because when  $\hbar\omega \gg k_B T$ , the temperature is not high enough to create even a single photon. By imposing a minimum energy on these high frequency modes, quantum mechanics ensures that they become frozen out.

### 3.2.4 Max Planck (1858-1947)

“A new scientific truth does not triumph by convincing its opponents and making them see the light, but rather because its opponents eventually die”

*Max Planck*

Planck was educated in Munich and, after a brief spell in Kiel, moved to take a professorship in Berlin. (The same position that Boltzmann had failed to turn up for).

For much of his early career, Planck was adamantly against the idea of atoms. In his view the laws of thermodynamics were inviolable. He could not accept that they sat on a foundation of probability. In 1882, he wrote “atomic theory, despite its great successes, will ultimately have to be abandoned”.

Twenty years later, Planck had changed his mind. In 1900, he applied Boltzmann’s statistical methods to photons to arrive at the result we derived above, providing the first hints of quantum mechanics. However, the key element of the derivation — that light comes in quanta — was not emphasised by Planck. Later, when quantum theory was developed, Planck refused once more to accept the idea of probability underlying physics. This time he did not change his mind.

### 3.3 Phonons

It is hard to imagine substances much more different than a gas and a solid. It is therefore quite surprising that we can employ our study of gases to accurately understand certain properties of solids. Consider a crystal of atoms of the type shown in the figure. The individual atoms are stuck fast in position: they certainly don’t act like a gas. But the vibrations of the atoms — in other words, sound waves — can be treated using the same formalism that we introduced for photons.

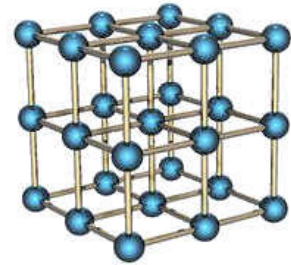

**Figure 16:**

#### 3.3.1 The Debye Model

Quantum mechanics turns electromagnetic waves into discrete packets of energy called photons. In exactly the same way, sounds waves in solids also come in discrete packets. They are called *phonons*. We’ll take the energy of a phonon to again be of the form

$$E = \hbar\omega = \hbar kc_s \quad (3.12)$$

where  $c_s$  is now the speed of sound rather than the speed of light.

The density of states for phonons is the same as that of photons (3.6) with two exceptions: we must replace the speed of light  $c$  with the speed of sound  $c_s$ ; and phonons have three polarization states rather than two. There are two transverse polarizations (like the photon) but also a longitudinal mode. The density of states is therefore

$$g(\omega)d\omega = \frac{3V}{2\pi^2c_s^2}\omega^2d\omega$$

There is one further important difference between phonons and photons. While light waves can have arbitrarily high frequency, sound waves cannot. This is because high frequency waves have small wavelengths,  $\lambda = 2\pi c_s/\omega$ . But there is a minimum wavelength in the problem set by the spacing between atoms. It is not possible for sound waves to propagate through a solid with wavelength smaller than the atomic spacing because there's nothing in the middle there to shake.

We will denote the maximum allowed phonon frequency as  $\omega_D$ . The minimum wavelength,  $\lambda_D$ , should be somewhere around the lattice spacing between atoms, which is  $(V/N)^{1/3}$ , so we expect that  $\omega_D \sim (N/V)^{1/3}c_s$ . But how can we work out the coefficient? There is a rather clever argument to determine  $\omega_D$  due to Debye. (So clever that he gets his initial on the frequency and his name on the section heading). We start by counting the number of single phonon states,

$$\int_0^{\omega_D} d\omega g(\omega) = \frac{V\omega_D^3}{2\pi^2c_s^3}$$

The clever bit of the argument is to identify this with the number of degrees of freedom in the solid. This isn't immediately obvious. The number of degrees of freedom in a lattice of  $N$  atoms is  $3N$  since each atom can move in three directions. But the number of single phonon states is counting collective vibrations of all the atoms together. Why should they be equal?

To really see what's going on, one should compute the correct energy eigenstates of the lattice and just count the number of single phonon modes with wavevectors inside the first Brillouin zone. (You will learn about Brillouin zones in the *Applications of Quantum Mechanics* course). But to get the correct intuition, we can think in the following way: in general the solid will have many phonons inside it and each of these phonons could sit in any one of the single-phonon states that we counted above. Suppose that there are three phonons sitting in the same state. We say that this state is occupied three times. In this language, each of the states above can be occupied an arbitrary number of times, restricted only by the energy available. If you want to describe the total state of the system, you need to say how many phonons are in the

first state, and how many are in the second state and so on. The number of one-phonon states is then playing the role of the number of degrees of freedom: it is the number of things you can excite.

The net result of this argument is to equate

$$3N = \frac{V\omega_D^3}{2\pi^2c_s^3} \Rightarrow \omega_D = \left(\frac{6\pi^2N}{V}\right)^{1/3} c_s$$

We see that  $\omega_D$  is related to the atomic spacing  $(V/N)^{1/3}$  as we anticipated above, but now we have the coefficient too. However, in some sense, the argument of Debye is “answer analysis”. It was constructed to ensure that we have the right high-temperature behaviour that we will see below.

From the maximum frequency  $\omega_D$  we can construct an associated energy scale,  $\hbar\omega_D$ , and temperature scale,

$$T_D = \frac{\hbar\omega_D}{k_B}$$

This is known as the Debye temperature. It provides a way of characterising all solids: it is the temperature at which the highest frequency phonon starts to become excited.  $T_D$  ranges from around 100K for very soft materials such as lead through to 2000K for hard materials such as diamond. Most materials have Debye temperatures around room temperature ( $\pm 100K$  or so).

## Heat Capacity of Solids

All that remains is to put the pieces together. Like photons, the number of phonons is not conserved. The partition function for phonons of a fixed frequency,  $\omega$ , is the same as for photons (3.7),

$$Z_\omega = 1 + e^{-\beta\hbar\omega} + e^{-2\beta\hbar\omega} + \dots = \frac{1}{1 - e^{-\beta\hbar\omega}}$$

Summing over all frequencies, the partition function is then

$$\log Z_{\text{phonon}} = \int_0^{\omega_D} d\omega g(\omega) \log Z_\omega$$

where the partition function  $Z_\omega$  for a single phonon of frequency  $\omega$  is the same as that of a photon (3.7). The total energy in sound waves is therefore

$$E = \int_0^{\omega_D} d\omega \frac{\hbar\omega g(\omega)}{e^{\beta\hbar\omega} - 1} = \frac{3V\hbar}{2\pi^2c_s^3} \int_0^{\omega_D} d\omega \frac{\omega^3}{e^{\beta\hbar\omega} - 1}$$

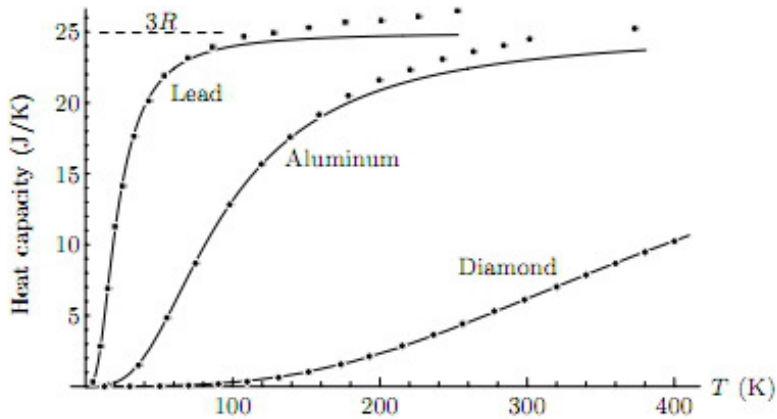

**Figure 17:** Experimental data for heat capacities. The solid line is the Debye prediction. (Source: D. Schroeder *An Introduction to Thermal Physics*)

We again rescale the integration variable to  $x = \beta\hbar\omega$  so the upper limit of the integral becomes  $x_D = T_D/T$ . Then we have

$$E = \frac{3V}{2\pi^2(\hbar c_s)^3} (k_B T)^4 \int_0^{T_D/T} dx \frac{x^3}{e^x - 1}$$

The integral is a function of  $T_D/T$ . It has no analytic expression. However, we can look in the two extremes. Firstly, for  $T \ll T_D$  we can replace the upper limit of the integral by infinity. We're then left with the same definite integral that we appeared for photons,  $I = \int_0^\infty dx \frac{x^3}{e^x - 1} = \pi^4/15$ . In this low-temperature regime, the heat capacity is proportional to  $T^3$ ,

$$C_V = \frac{\partial E}{\partial T} = \frac{2\pi^2 V k_B^4}{5\hbar^3 c_s^3} T^3 \quad (T \ll T_D) \quad (3.13)$$

It is often expressed in terms of the Debye temperature  $T_D$ , so it reads

$$C_V = N k_B \frac{12\pi^4}{5} \left( \frac{T}{T_D} \right)^3 \quad (3.14)$$

In contrast, at temperatures  $T \gg T_D$  we only integrate over small values of  $x$ , allowing us to Taylor expand the integrand,

$$\int_0^{T_D/T} dx \frac{x^3}{e^x - 1} = \int_0^{T_D/T} dx (x^2 + \dots) = \frac{1}{3} \left( \frac{T_D}{T} \right)^3 + \dots$$

This ensures that the energy grows linearly with  $T$  and the heat capacity tends towards a constant value

$$C_V = \frac{V k_B^4 T_D^3}{2\pi^2 \hbar^3 c_s^3} = 3Nk_B \quad (T \gg T_D) \quad (3.15)$$

This high-temperature behaviour has been known experimentally since the early 1800's. It is called the *Dulong-Petit law*. Debye's argument for the value of  $\omega_D$  was basically constructed to reproduce the coefficient  $3N$  in the formula above. This was known experimentally, but also from an earlier model of vibrations in a solid due to Einstein. (You met the Einstein model in the first problem sheet). Historically, the real success of the Debye model was the correct prediction of the  $T^3$  behaviour of  $C_V$  at low temperatures.

In most materials the heat capacity is dominated by the phonon contribution. (In metals there is an additional contribution from conduction electrons that we will calculate in Section 3.6). The heat capacity of three materials is shown in Figure 17, together with the predictions from the Debye model. As you can see, it works very well! The deviation from theory at high temperatures is due to differences between  $C_V$  and  $C_p$ , the heat capacity at constant pressure.

### What's Wrong with the Debye Model?

As we've seen, the Debye model is remarkably accurate in capturing the heat capacities of solids. Nonetheless, it is a caricature of the physics. The most glaring problem is our starting point (3.12). The relationship  $E = \hbar\omega$  between energy and frequency is fine; the mistake is the relationship between frequency  $\omega$  and wavevector (or momentum)  $k$ , namely  $\omega = kc_s$ . Equations of this type, relating energy and momentum, are called *dispersion relations*. It turns out that that the dispersion relation for phonons is a little more complicated.

It is not hard to compute the dispersion relation for phonons. (You will, in fact, do this calculation in the *Applications of Quantum Mechanics* course). For simplicity, we'll work with a one dimensional periodic lattice of  $N$  atoms as shown in the figure. The equilibrium position of each atom is  $x_l = la$  and we impose periodic boundary conditions by insisting that  $x_{N+1} \equiv x_1$ . Let  $u_l$  be the deviation from equilibrium,  $u_l = x_l - la$ . If we approximate the bonds joining the atoms as har-

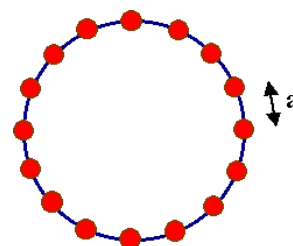

Figure 18:

monic oscillators, the Hamiltonian governing the vibrations is

$$H = \frac{1}{2m} \sum_i \dot{u}_i^2 + \frac{\alpha}{2} \sum_i (u_i - u_{i+1})^2$$

where  $\alpha$  is a parameter governing the strength of the bonds between atoms. The equation of motion is

$$\ddot{u}_i = \frac{\alpha}{m} (2u_i - u_{i+1} - u_{i-1})$$

This is easily solved by the discrete Fourier transform. We make the ansatz

$$u_l = \frac{1}{\sqrt{N}} \sum_k \tilde{u}_k e^{i(kla - \omega_k t)}$$

Plugging this into the equation of motion gives the dispersion relation

$$\omega_k = 2\sqrt{\frac{\alpha}{m}} \left| \sin\left(\frac{ka}{2}\right) \right|$$

To compute the partition function correctly in this model, we would have to revisit the density of states using the new dispersion relation  $E(k) = \hbar\omega_k$ . The resulting integrals are messy. However, at low temperatures only the smallest frequency modes are excited and, for small  $ka$ , the sin function is approximately linear. This means that we get back to the dispersion relation that we used in the Debye model,  $\omega = kc_s$ , with the speed of sound given by  $c_s = a\sqrt{\alpha/m}$ . Moreover, at very high temperatures it is simple to check that this model gives the Dulong-Petit law as expected. It deviates from the Debye model only at intermediate temperatures and, even here, this deviation is mostly negligible.

### 3.4 The Diatomic Gas Revisited

With a bit of quantum experience under our belt, we can look again at the diatomic gas that we discussed in Section 2.4. Recall that the classical prediction for the heat capacity —  $C_V = \frac{7}{2}Nk_B$  — only agrees with experiment at very high temperatures. Instead, the data suggests that as the temperature is lowered, the vibrational modes and the rotational modes become frozen out. But this is exactly the kind of behaviour that we expect for a quantum system where there is a minimum energy necessary to excite each degree of freedom. Indeed, this “freezing out” of modes saved us from ultra-violet catastrophe in the case of blackbody radiation and gave rise to a reduced heat capacity at low temperatures for phonons.



Let's start with the rotational modes, described by the Hamiltonian (2.18). Treating this as a quantum Hamiltonian, it has energy levels

$$E = \frac{\hbar^2}{2I}j(j+1) \quad j = 0, 1, 2, \dots$$

The degeneracy of each energy level is  $2j + 1$ . Thus the rotational partition function for a single molecule is

$$Z_{\text{rot}} = \sum_{j=0}^{\infty} (2j+1)e^{-\beta\hbar^2j(j+1)/2I}$$

When  $T \gg \hbar^2/2Ik_B$ , we can approximate the sum by the integral to get

$$Z_{\text{rot}} \approx \int_0^{\infty} dx (2x+1)e^{-\beta\hbar^2x(x+1)/2I} = \frac{2I}{\beta\hbar^2}$$

which agrees with our result for the classical partition function (2.19).

In contrast, for  $T \ll \hbar^2/2Ik_B$  all states apart from  $j = 0$  effectively decouple and we have simply  $Z_{\text{rot}} \approx 1$ . At these temperatures, the rotational modes are frozen at temperatures accessible in experiment so only the translational modes contribute to the heat capacity.

This analysis also explains why there is no rotational contribution to the heat capacity of a monatomic gas. One could try to argue this away by saying that atoms are point particles and so can't rotate. But this simply isn't true. The correct argument is that the moment of inertia  $I$  of an atom is very small and the rotational modes are frozen. Similar remarks apply to rotation about the symmetry axis of a diatomic molecule.

The vibrational modes are described by the harmonic oscillator. You already computed the partition function for this on the first examples sheet (and, in fact, implicitly in the photon and phonon calculations above). The energies are

$$E = \hbar\omega\left(n + \frac{1}{2}\right)$$

and the partition function is

$$Z_{\text{vib}} = \sum_n e^{-\beta\hbar\omega(n+\frac{1}{2})} = e^{-\beta\hbar\omega/2} \sum_n e^{-\beta\hbar\omega n} = \frac{e^{-\beta\hbar\omega/2}}{1 - e^{-\beta\hbar\omega}} = \frac{1}{2 \sinh(\beta\hbar\omega/2)}$$

At high temperatures  $\beta\hbar\omega \ll 1$ , we can approximate the partition function as  $Z_{\text{vib}} \approx 1/\beta\hbar\omega$  which again agrees with the classical result (2.20). At low temperatures  $\beta\hbar\omega \gg$

1, the partition function becomes  $Z_{\text{vib}} \approx e^{-\beta\hbar\omega/2}$ . This is a contribution from the zero-point energy of the harmonic oscillator. It merely gives the expected additive constant to the energy per particle,

$$E_{\text{vib}} = -\frac{\partial}{\partial\beta} \log Z_{\text{vib}} \approx \frac{\hbar\omega}{2}$$

and doesn't contribute the heat capacity. Once again, we see how quantum effects explain the observed behaviour of the heat capacity of the diatomic gas. The end result is a graph that looks like that shown in Figure 11.

### 3.5 Bosons

For the final two topics of this section, we will return again to the simple monatomic ideal gas. The classical treatment that we described in Section 2.2 has limitations. As the temperature decreases, the thermal de Broglie wavelength,

$$\lambda = \sqrt{\frac{2\pi\hbar^2}{mk_B T}}$$

gets larger. Eventually it becomes comparable to the inter-particle separation,  $(V/N)^{1/3}$ . At this point, quantum effects become important. If the particles are non-interacting, there is really only one important effect that we need to consider: quantum statistics.

Recall that in quantum mechanics, particles come in two classes: bosons and fermions. Which class a given particle falls into is determined by its spin, courtesy of the spin-statistics theorem. Integer spin particles are bosons. This means that any wavefunction must be symmetric under the exchange of two particles,

$$\psi(\vec{r}_1, \vec{r}_2) = \psi(\vec{r}_2, \vec{r}_1)$$

Particles with  $\frac{1}{2}$ -integer spin are fermions. They have an anti-symmetrized wavefunction,

$$\psi(\vec{r}_1, \vec{r}_2) = -\psi(\vec{r}_2, \vec{r}_1)$$

At low temperatures, the behaviour of bosons and fermions is very different. All familiar fundamental particles such as the electron, proton and neutron are fermions. But an atom that contains an even number of fermions acts as a boson as long as we do not reach energies large enough to dislodge the constituent particles from their bound state. Similarly, an atom consisting of an odd number of electrons, protons and neutrons will be a fermion. (In fact, the proton and neutron themselves are not fundamental: they

are fermions because they contain three constituent quarks, each of which is a fermion. If the laws of physics were different so that four quarks formed a bound state rather than three, then both the proton and neutron would be bosons and, as we will see in the next two sections, nuclei would not exist!).

We will begin by describing the properties of bosons and then turn to a discussion of fermions to Section 3.6.

### 3.5.1 Bose-Einstein Distribution

We'll change notation slightly from earlier sections and label the single particle quantum states of the system by  $|r\rangle$ . (We used  $|n\rangle$  previously, but  $n$  will be otherwise occupied for most of this section). The single particle energies are then  $E_r$  and we'll assume that our particles are non-interacting. In that case, you might think that to specify the state of the whole system, you would need to say which state particle 1 is in, and which state particle 2 is in, and so on. But this is actually too much information because particle 1 and particle 2 are indistinguishable. To specify the state of the whole system, we don't need to attach labels to each particle. Instead, it will suffice to say how many particles are in state 1 and how many particles are in state 2 and so on.

We'll denote the number of particles in state  $|r\rangle$  as  $n_r$ . If we choose to work in the canonical ensemble, we must compute the partition function,

$$Z = \sum_{\{n_r\}} e^{-\beta \sum_r n_r E_r}$$

where the sum is over all possible ways of partitioning  $N$  particles into sets  $\{n_r\}$  subject to the constraint that  $\sum_r n_r = N$ . Unfortunately, the need to impose this constraint makes the sums tricky. This means that the canonical ensemble is rather awkward when discussing indistinguishable particles. It turns out to be *much* easier to work in the grand canonical ensemble where we introduce a chemical potential  $\mu$  and allow the total number of particles  $N$  to fluctuate.

Life is simplest if we think of each state  $|r\rangle$  in turn. In the grand canonical ensemble, a given state can be populated by an arbitrary number of particles. The grand partition function for this state is

$$\mathcal{Z}_r = \sum_{n_r} e^{-\beta n_r (E_r - \mu)} = \frac{1}{1 - e^{-\beta(E_r - \mu)}}$$

Notice that we've implicitly assumed that the sum above converges, which is true only if  $(E_r - \mu) > 0$ . But this should be true for all states  $E_r$ . We will set the ground state

to have energy  $E_0 = 0$ , so the grand partition function for a Bose gas only makes sense if

$$\mu < 0 \tag{3.16}$$

Now we use the fact that all the occupation of one state is independent of any other. The full grand partition function is then

$$\mathcal{Z} = \prod_r \frac{1}{1 - e^{-\beta(E_r - \mu)}}$$

From this we can compute the average number of particles,

$$N = \frac{1}{\beta} \frac{\partial}{\partial \mu} \log \mathcal{Z} = \sum_r \frac{1}{e^{\beta(E_r - \mu)} - 1} \equiv \sum_r \langle n_r \rangle$$

Here  $\langle n_r \rangle$  denotes the average number of particles in the state  $|r\rangle$ ,

$$\langle n_r \rangle = \frac{1}{e^{\beta(E_r - \mu)} - 1} \tag{3.17}$$

This is the *Bose-Einstein distribution*. In what follows we will always be interesting in the thermodynamic limit where fluctuations around the average are negligible. For this reason, we will allow ourselves to be a little sloppy in notation and we write the average number of particles in  $|r\rangle$  as  $n_r$  instead of  $\langle n_r \rangle$ .

Notice that we've seen expressions of the form (3.17) already in the calculations for photons and phonons — see, for example, equation (3.7). This isn't coincidence: both photons and phonons are bosons and the origin of this term in both calculations is the same: it arises because we sum over the number of particles in a given state rather than summing over the states for a single particle. As we mentioned in the Section on blackbody radiation, it is not really correct to think of photons or phonons in the grand canonical ensemble because their particle number is not conserved. Nonetheless, the equations are formally equivalent if one just sets  $\mu = 0$ .

In what follows, it will save ink if we introduce the *fugacity*

$$z = e^{\beta\mu} \tag{3.18}$$

Since  $\mu < 0$ , we have  $0 < z < 1$ .

## Ideal Bose Gas

Let's look again at a gas of non-relativistic particles, now through the eyes of quantum mechanics. The energy is

$$E = \frac{\hbar^2 k^2}{2m}$$

As explained in Section 3.1, we can replace the sum over discrete momenta with an integral over energies as long as we correctly account for the density of states. This was computed in (3.2) and we reproduce the result below:

$$g(E) = \frac{V}{4\pi^2} \left( \frac{2m}{\hbar^2} \right)^{3/2} E^{1/2} \quad (3.19)$$

From this, together with the Bose-Einstein distribution, we can easily compute the total number of particles in the gas,

$$N = \int dE \frac{g(E)}{z^{-1}e^{\beta E} - 1} , \quad (3.20)$$

There is an obvious, but important, point to be made about this equation. If we can do the integral (and we will shortly) we will have an expression for the number of particles in terms of the chemical potential and temperature:  $N = N(\mu, T)$ . That means that if we keep the chemical potential fixed and vary the temperature, then  $N$  will change. But in most experimental situations,  $N$  is fixed and we're working in the grand canonical ensemble only because it is mathematically simpler. But nothing is for free. The price we pay is that we will have to invert equation (3.20) to get it in the form  $\mu = \mu(N, T)$ . Then when we change  $T$ , keeping  $N$  fixed,  $\mu$  will change too. We have already seen an example of this in the ideal gas where the chemical potential is given by (2.14).

The average energy of the Bose gas is,

$$E = \int dE \frac{Eg(E)}{z^{-1}e^{\beta E} - 1} , \quad (3.21)$$

And, finally, we can compute the pressure. In the grand canonical ensemble this is,

$$pV = \frac{1}{\beta} \log \mathcal{Z} = -\frac{1}{\beta} \int dE g(E) \log (1 - ze^{-\beta E})$$

We can manipulate this last expression using an integration by parts. Because  $g(E) \sim E^{1/2}$ , this becomes

$$pV = \frac{2}{3} \int dE \frac{Eg(E)}{z^{-1}e^{\beta E} - 1} = \frac{2}{3} E \quad (3.22)$$

This is implicitly the equation of state. But we still have a bit of work to do. Equation (3.21) gives us the energy as a function of  $\mu$  and  $T$ . And, by the time we have inverted (3.20), it gives us  $\mu$  as a function of  $N$  and  $T$ . Substituting both of these into (3.22) will give the equation of state. We just need to do the integrals...

### 3.5.2 A High Temperature Quantum Gas is (Almost) Classical

Unfortunately, the integrals (3.20) and (3.21) look pretty fierce. Shortly, we will start to understand some of their properties, but first we look at a particularly simple limit. We will expand the integrals (3.20), (3.21) and (3.22) in the limit  $z = e^{\beta\mu} \ll 1$ . We'll figure out the meaning of this expansion shortly (although there's a clue in the title of this section if you're impatient). Let's look at the particle density (3.20),

$$\begin{aligned} \frac{N}{V} &= \frac{1}{4\pi^2} \left( \frac{2m}{\hbar^2} \right)^{3/2} \int_0^\infty dE \frac{E^{1/2}}{z^{-1}e^{\beta E} - 1} \\ &= \frac{1}{4\pi^2} \left( \frac{2m}{\hbar^2} \right)^{3/2} \int_0^\infty dE \frac{ze^{-\beta E} E^{1/2}}{1 - ze^{-\beta E}} \\ &= \frac{1}{4\pi^2} \left( \frac{2m}{\hbar^2} \right)^{3/2} \frac{z}{\beta^{3/2}} \int_0^\infty dx \sqrt{x} e^{-x} (1 + ze^{-x} + \dots) \end{aligned}$$

where we made the simple substitution  $x = \beta E$ . The integrals are all of the Gaussian type and can be easily evaluated by making one further substitution  $x = u^2$ . The final answer can be conveniently expressed in terms of the thermal wavelength  $\lambda$ ,

$$\frac{N}{V} = \frac{z}{\lambda^3} \left( 1 + \frac{z}{2\sqrt{2}} + \dots \right) \quad (3.23)$$

Now we've got the answer, we can ask what we've done! What kind of expansion is  $z \ll 1$ ? From the above expression, we see that the expansion is consistent only if  $\lambda^3 N/V \ll 1$ , which means that the thermal wavelength is much less than the interparticle spacing. But this is true at high temperatures: the expansion  $z \ll 1$  is a high temperature expansion.

At first glance, it is surprising that  $z = e^{\beta\mu} \ll 1$  corresponds to high temperatures. When  $T \rightarrow \infty$ ,  $\beta \rightarrow 0$  so naively it looks as if  $z \rightarrow 1$ . But this is too naive. If we keep the particle number  $N$  fixed in (3.20) then  $\mu$  must vary as we change the temperature, and it turns out that  $\mu \rightarrow -\infty$  faster than  $\beta \rightarrow 0$ . To see this, notice that to leading order we need  $z/\lambda^3$  to be constant, so  $z \sim T^{-3/2}$ .

## High Temperature Equation of State of a Bose Gas

We now wish to compute the equation of state. We know from (3.22) that  $pV = \frac{2}{3}E$ . So we need to compute  $E$  using the same  $z \ll 1$  expansion as above. From (3.21), the energy density is

$$\begin{aligned} \frac{E}{V} &= \frac{1}{4\pi^2} \left( \frac{2m}{\hbar^2} \right)^{3/2} \int_0^\infty dE \frac{E^{3/2}}{z^{-1}e^{\beta E} - 1} \\ &= \frac{1}{4\pi^2} \left( \frac{2m}{\hbar^2} \right)^{3/2} \frac{z}{\beta^{5/2}} \int_0^\infty dx x^{3/2} e^{-x} (1 + ze^{-x} + \dots) \\ &= \frac{3z}{2\lambda^3\beta} \left( 1 + \frac{z}{4\sqrt{2}} + \dots \right) \end{aligned} \quad (3.24)$$

The next part's a little fiddly. We want to eliminate  $z$  from the expression above in favour of  $N/V$ . To do this we invert (3.23), remembering that we're working in the limit  $z \ll 1$  and  $\lambda^3 N/V \ll 1$ . This gives

$$z = \frac{\lambda^3 N}{V} \left( 1 - \frac{1}{2\sqrt{2}} \frac{\lambda^3 N}{V} + \dots \right)$$

which we then substitute into (3.24) to get

$$E = \frac{3N}{2\beta} \left( 1 - \frac{1}{2\sqrt{2}} \frac{\lambda^3 N}{V} + \dots \right) \left( 1 + \frac{1}{4\sqrt{2}} \frac{\lambda^3 N}{V} + \dots \right)$$

and finally we substitute this into  $pV = \frac{2}{3}E$  to get the equation of state of an ideal Bose gas at high temperatures,

$$pV = Nk_B T \left( 1 - \frac{\lambda^3 N}{4\sqrt{2}V} + \dots \right) \quad (3.25)$$

which reproduces the classical ideal gas, together with a term that we can identify as the second virial coefficient in the expansion (2.21). However, this correction to the pressure hasn't arisen from any interactions among the atoms: it is solely due to quantum statistics. We see that the effect of bosonic statistics on the high temperature gas is to reduce the pressure.

### 3.5.3 Bose-Einstein Condensation

We now turn to the more interesting question: what happens to a Bose gas at low temperatures? Recall that for convergence of the grand partition function we require  $\mu < 0$  so that  $z = e^{\beta\mu} \in (0, 1)$ . Since the high temperature limit is  $z \rightarrow 0$ , we'll anticipate that quantum effects and low temperatures come about as  $z \rightarrow 1$ .

Recall that the number density is given by (3.20) which we write as

$$\frac{N}{V} = \frac{1}{4\pi^2} \left( \frac{2mk_B T}{\hbar^2} \right)^{3/2} \int_0^\infty dx \frac{x^{1/2}}{z^{-1}e^x - 1} \equiv \frac{1}{\lambda^3} g_{3/2}(z) \quad (3.26)$$

where the function  $g_{3/2}(z)$  is one of a class of functions which appear in the story of Bose gases,

$$g_n(z) = \frac{1}{\Gamma(n)} \int_0^\infty dx \frac{x^{n-1}}{z^{-1}e^x - 1} \quad (3.27)$$

These functions are also known as polylogarithms and sometimes denoted as  $Li_n(z) = g_n(z)$ . The function  $g_{3/2}$  is relevant for the particle number and the function  $g_{5/2}$  appears in the calculation of the energy in (3.21). For reference, the gamma function has value  $\Gamma(3/2) = \sqrt{\pi}/2$ . (Do not confuse these functions  $g_n(z)$  with the density of states  $g(E)$ . They are not related; they just share a similar name).

In Section 3.5.2 we looked at (3.26) in the  $T \rightarrow \infty$  limit. There we saw that  $\lambda \rightarrow 0$  but the function  $g_{3/2}(z) \rightarrow 0$  in just the right way to compensate and keep  $N/V$  fixed. What now happens in the other limit,  $T \rightarrow 0$  and  $\lambda \rightarrow \infty$ . One might harbour the hope that  $g_{3/2}(z) \rightarrow \infty$  and again everything balances nicely with  $N/V$  remaining constant. We will now show that this can't happen.

A couple of manipulations reveals that the integral (3.27) can be expressed in terms of a sum,

$$\begin{aligned} g_n(z) &= \frac{1}{\Gamma(n)} \int dx \frac{zx^{n-1}e^{-x}}{1 - ze^{-x}} \\ &= \frac{1}{\Gamma(n)} z \int dx x^{n-1} e^{-x} \sum_{m=0}^{\infty} z^m e^{-mx} \\ &= \frac{1}{\Gamma(n)} \sum_{m=1}^{\infty} z^m \int dx x^{n-1} e^{-mx} \\ &= \frac{1}{\Gamma(n)} \sum_{m=1}^{\infty} \frac{z^m}{m^n} \int du u^{n-1} e^{-u} \end{aligned}$$

But the integral that appears in the last line above is nothing but the definition of the gamma function  $\Gamma(n)$ . This means that we can write

$$g_n(z) = \sum_{m=1}^{\infty} \frac{z^m}{m^n} \quad (3.28)$$



We see that  $g_n(z)$  is a monotonically increasing function of  $z$ . Moreover, at  $z = 1$ , it is equal to the Riemann zeta function

$$g_n(1) = \zeta(n)$$

For our particular problem it will be useful to know that  $\zeta(3/2) \approx 2.612$ .

Let's now return to our story. As we decrease  $T$  in (3.26), keeping  $N/V$  fixed,  $z$  and hence  $g_{3/2}(z)$  must both increase. But  $z$  can't take values greater than 1. When we reach  $z = 1$ , let's denote the temperature as  $T = T_c$ . We can determine  $T_c$  by setting  $z = 1$  in equation (3.26),

$$T_c = \left( \frac{2\pi\hbar^2}{k_B m} \right) \left( \frac{1}{\zeta(3/2)} \frac{N}{V} \right)^{2/3} \quad (3.29)$$

What happens if we try to decrease the temperature below  $T_c$ ? Taken at face value, equation (3.26) tells us that the number of particles should decrease. But that's a stupid conclusion! It says that we can make particles disappear by making them cold. Where did they go? We may be working in the grand canonical ensemble, but in the thermodynamic limit we expect  $\Delta N \sim 1/\sqrt{N}$  which is too small to explain our missing particles. Where did we misplace them? It looks as if we made a mistake in the calculation.

In fact, we did make a mistake in the calculation. It happened right at the beginning. Recall that back in Section 3.1 we replaced the sum over states with an integral over energies,

$$\sum_{\vec{k}} \approx \frac{V(2m)^{3/2}}{4\pi^2\hbar^3} \int dE E^{1/2}$$

Because of the weight  $\sqrt{E}$  in the integrand, the ground state with  $E = 0$  doesn't contribute to the integral. We can use the Bose-Einstein distribution (3.17) to compute the number of states that we expect to be missing because they sit in this  $E = 0$  ground state,

$$n_0 = \frac{1}{z^{-1} - 1} \quad (3.30)$$

For most values of  $z \in (0, 1)$ , there are just a handful of particles sitting in this lowest state and it doesn't matter if we miss them. But as  $z$  gets *very very* close to 1 (meaning  $z \approx 1 - 1/N$ ) then we get a macroscopic number of particles occupying the ground state.

It is a simple matter to redo our calculation taking into account the particles in the ground state. Equation (3.26) is replaced by

$$N = \frac{V}{\lambda^3} g_{3/2}(z) + \frac{z}{1-z}$$

Now there's no problem keeping  $N$  fixed as we take  $z$  close to 1 because the additional term diverges. This means that if we have finite  $N$ , then as we decrease  $T$  we can never get to  $z = 1$ . Instead,  $z$  must level out around  $z \approx 1 - 1/N$  as  $T \rightarrow 0$ .

For  $T < T_c$ , the number of particles sitting in the ground state is  $\mathcal{O}(N)$ . Some simple algebra allows us to determine that fraction of particles in the ground state is

$$\frac{n_0}{N} = 1 - \frac{V}{N\lambda^3} \zeta(3/2) = 1 - \left(\frac{T}{T_c}\right)^{3/2} \quad (3.31)$$

At temperatures  $T < T_c$ , a macroscopic number of atoms discard their individual identities and merge into a communist collective, a single quantum state so large that it can be seen with the naked eye. This is known as the *Bose-Einstein condensate*. It provides an exquisitely precise playground in which many quantum phenomena can be tested.

### Bose-Einstein Condensates in the Lab

Bose-Einstein condensates (often shortened to BECs) of weakly interacting atoms were finally created in 1995, some 70 years after they were first predicted. These first BECs were formed of Rubidium, Sodium or Lithium and contained between  $N \sim 10^4 \rightarrow 10^7$  atoms. The transition temperatures needed to create these condensates are extraordinarily small, around  $T_c \sim 10^{-7}K$ . Figure 20 shows the iconic colour enhanced plots that reveal the existence of the condensate. To create these plots, the atoms are stored in a magnetic trap which is then turned off. A picture is taken of the atom cloud a short time  $t$  later when the atoms have travelled a distance  $\hbar kt/m$ . The grey UFO-like smudges above are the original pictures. From the spread of atoms, the momentum distribution of the cloud is inferred and this is what is shown in Figure 20. The peak that appears in the last two plots reveals that a substantial number of atoms were indeed sitting in the momentum ground state. (This is not a  $k = 0$  state because of the finite trap and the Heisenberg uncertainty relation). The initial discoverers of BECs, Eric Cornell and Carl Wieman from Boulder and Wolfgang Ketterle from MIT, were awarded the 2001 Nobel prize in physics.

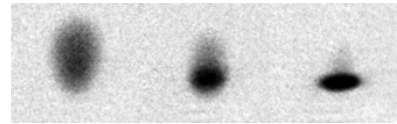

**Figure 19:** UFO=BEC

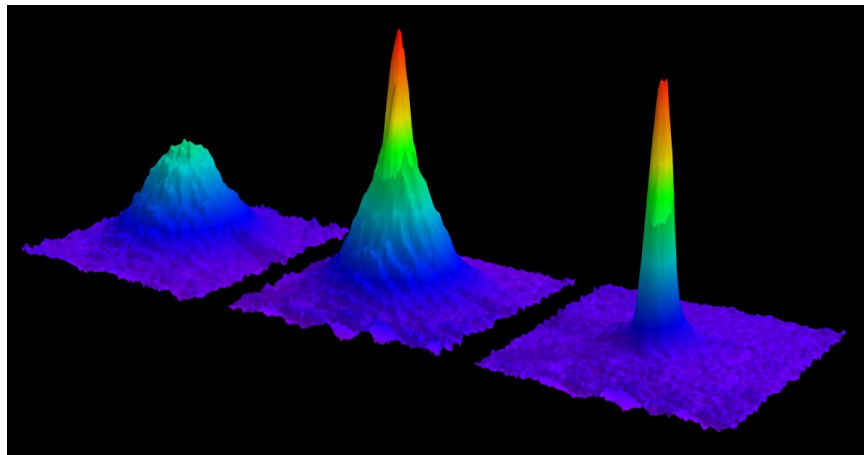

**Figure 20:** The velocity distribution of Rubidium atoms, taken from the Ketterle lab at MIT. The left-hand picture shows  $T > T_c$ , just before the condensate forms. The middle and right-hand pictures both reveal the existence of the condensate.

### Low Temperature Equation of State of a Bose Gas

The pressure of the ideal Bose gas was computed in (3.22). We can express this in terms of our new favourite functions (3.27) as

$$p = \frac{2E}{3V} = \frac{k_B T}{\lambda^3} g_{5/2}(z) \quad (3.32)$$

Formally there is also a contribution from the ground state, but it is  $\log(1 - z)/V$  which is a factor of  $N$  smaller than the term above and can be safely ignored. At low temperatures,  $T < T_c$ , we have  $z \approx 1$  and

$$p = \frac{k_B T}{\lambda^3} \zeta(5/2)$$

So at low temperatures, the equation of state of the ideal Bose gas is very different from the classical, high temperature, behaviour. The pressure scales as  $p \sim T^{5/2}$  (recall that there is a factor of  $T^{3/2}$  lurking in the  $\lambda$ ). More surprisingly, the pressure is independent of the density of particles  $N/V$ .

#### 3.5.4 Heat Capacity: Our First Look at a Phase Transition

Let's try to understand in more detail what happens as we pass through the critical temperature  $T_c$ . We will focus on how the heat capacity behaves on either side of the critical temperature.

We've already seen in (3.32) that we can express the energy in terms of the function  $g_{5/2}(z)$ ,

$$\frac{E}{V} = \frac{3 k_B T}{2 \lambda^3} g_{5/2}(z)$$

so the heat capacity becomes

$$\frac{C_V}{V} = \frac{1}{V} \frac{dE}{dT} = \frac{15 k_B}{4 \lambda^3} g_{5/2}(z) + \frac{3 k_B T}{2 \lambda^3} \frac{dg_{5/2}}{dz} \frac{dz}{dT} \quad (3.33)$$

The first term gives a contribution both for  $T < T_c$  and for  $T > T_c$ . However, the second term includes a factor of  $dz/dT$  and  $z$  is a very peculiar function of temperature: for  $T > T_c$ , it is fairly smooth, dropping off at  $T = T_c$ . However, as  $T \rightarrow T_c$ , the fugacity rapidly levels off to the value  $z \approx 1 - 1/N$ . For  $T < T_c$ ,  $z$  doesn't change very much at all. The net result of this is that the second term only contributes when  $T > T_c$ . Our goal here is to understand how this contribution behaves as we approach the critical temperature.

Let's begin with the easy bit. Below the critical temperature,  $T < T_c$ , only the first term in (3.33) contributes and we may happily set  $z = 1$ . This gives the heat capacity,

$$C_V = \frac{15V}{4\lambda^3} \zeta(5/2) \sim T^{3/2} \quad (3.34)$$

Now we turn to  $T > T_c$ . Here we have  $z < 1$ , so  $g_{5/2}(z) < g_{5/2}(1)$ . We also have  $dz/dT < 0$ . This means that the heat capacity decreases for  $T > T_c$ . But we know that for  $T < T_c$ ,  $C_V \sim T^{3/2}$  so the heat capacity must have a maximum at  $T = T_c$ . Our goal in this section is to understand a little better what the function  $C_V$  looks like in this region.

To compute the second term in (3.33) we need to understand both  $g'_{5/2}$  and how  $z$  changes with  $T$  as we approach  $T_c$  from above. The first calculation is easy if we use our expression (3.28),

$$g_n(z) = \sum_{m=1}^{\infty} \frac{z^m}{m^n} \quad \Rightarrow \quad \frac{d}{dz} g_n(z) = \frac{1}{z} g_{n-1}(z) \quad (3.35)$$

As  $T \rightarrow T_c$  from above,  $dg_{5/2}/dT \rightarrow \zeta(3/2)$ , a constant. All the subtleties lie in the remaining term,  $dz/dT$ . After all, this is the quantity which is effectively vanishing for  $T < T_c$ . What's it doing at  $T > T_c$ ? To figure this out is a little more involved. We start with our expression (3.26),

$$g_{3/2}(z) = \frac{N\lambda^3}{V} \quad T > T_c \quad (3.36)$$

and we'll ask what happens to the function  $g_{3/2}(z)$  as  $z \rightarrow 1$ , keeping  $N$  fixed. We know that exactly at  $z = 1$ ,  $g_{3/2}(1) = \zeta(3/2)$ . But how does it approach this value? To answer this, it is actually simplest to look at the derivative  $dg_{3/2}/dz = g_{1/2}/z$ , where

$$g_{1/2}(z) = \frac{1}{\Gamma(1/2)} \int_0^\infty dx \frac{x^{-1/2}}{z^{-1}e^x - 1}$$

The reason for doing this is that  $g_{1/2}$  diverges as  $z \rightarrow 1$  and it is generally easier to isolate divergent parts of a function than some finite piece. Indeed, we can do this straightforwardly for  $g_{1/2}$  by looking at the integral very close to  $x = 0$ , we can write

$$\begin{aligned} g_{1/2}(z) &= \frac{1}{\Gamma(1/2)} \int_0^\epsilon dx \frac{x^{-1/2}}{z^{-1}(1+x) - 1} + \text{finite} \\ &= \frac{z}{\Gamma(1/2)} \int_0^\epsilon dx \frac{x^{-1/2}}{(1-z) + x} + \dots \\ &= \frac{2z}{\sqrt{1-z}} \frac{1}{\Gamma(1/2)} \int_0^\epsilon du \frac{1}{1+u^2} + \dots \end{aligned}$$

where, in the last line, we made the substitution  $u = \sqrt{x/(1-z)}$ . So we learn that as  $z \rightarrow 1$ ,  $g_{1/2}(z) \rightarrow z(1-z)^{-1/2}$ . But this is enough information to tell us how  $g_{3/2}$  approaches its value at  $z = 1$ : it must be

$$g_{3/2}(z) \approx \zeta(3/2) + A(1-z)^{1/2} + \dots$$

for some constant  $A$ . Inserting this into our equation (3.36) and rearranging, we find that as  $T \rightarrow T_c$  from above,

$$\begin{aligned} z &\approx 1 - \frac{1}{A^2} \left( \zeta(3/2) - \frac{N\lambda^3}{V} \right)^2 \\ &= 1 - \frac{\zeta(3/2)^2}{A^2} \left( \left( \frac{T}{T_c} \right)^{3/2} - 1 \right)^2 \\ &\approx 1 - B \left( \frac{T - T_c}{T_c} \right)^2 \end{aligned}$$

where, in the second line, we used the expression of the critical temperature (3.29).  $B$  is some constant that we could figure out with a little more effort, but it won't be important for our story. From the expression above, we can now determine  $dz/dT$  as  $T \rightarrow T_c$ . We see that it vanishes linearly at  $T = T_c$ .

Putting all this together, we can determine the expression for the heat capacity (3.33) when  $T > T_c$ . We're not interested in the coefficients, so we'll package a bunch of numbers of order 1 into a constant  $b$  and the end result is

$$C_V = \frac{15Vk_B}{4\lambda^3} g_{5/2}(z) - b \left( \frac{T - T_c}{T_c} \right)$$

The first term above goes smoothly over to the expression (3.34) for  $C_V$  when  $T < T_c$ . But the second term is only present for  $T > T_c$ . Notice that it goes to zero as  $T \rightarrow T_c$ , which ensures that the heat capacity is continuous at this point. But the derivative is *not* continuous. A sketch of the heat capacity is shown in the figure.

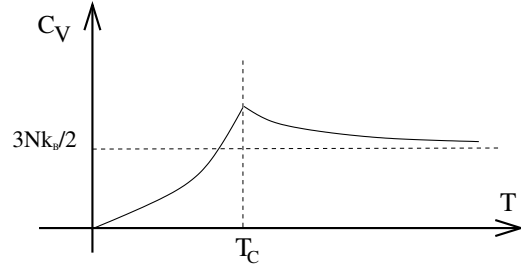

**Figure 21:** Heat Capacity for a BEC

Functions in physics are usually nice and smooth. How did we end up with a discontinuity in the derivative? In fact, if we work at finite  $N$ , strictly speaking everything is nice and smooth. There is a similar contribution to  $dz/dT$  even at  $T < T_c$ . We can see that by looking again at the expressions (3.30) and (3.31), which tell us

$$z = \left( 1 + \frac{1}{n_0} \right)^{-1} = \left( 1 + \frac{1}{N} \frac{1}{1 - (T/T_c)^{3/2}} \right)^{-1} \quad (T < T_c)$$

The difference is that while  $dz/dT$  is of order one above  $T_c$ , it is of order  $1/N$  below  $T_c$ . In the thermodynamic limit,  $N \rightarrow \infty$ , this results in the discontinuity that we saw above. This is a general lesson: phase transitions with their associated discontinuities can only arise in strictly infinite systems. There are no phase transitions in finite systems.

### Superfluid Helium-4

A similar, but much more pronounced, discontinuity is seen in Helium-4 as it becomes a superfluid, a transition which occurs at 2.17 K. The atom contains two protons, two neutrons and two electrons and is therefore a boson. (In contrast, Helium-3 contains just a single neutron and is a fermion). The experimental data for the heat capacity of Helium-4 is shown on the right. The successive graphs are zooming in on the phase transition: the scales are (from left to right) Kelvin, milliKelvin and microKelvin. The discontinuity is often called the *lambda* transition on account of the shape of this graph.

There is a close connection between Bose-Einstein condensation described above and superfluids: strictly speaking a non-interacting Bose-Einstein condensate is not a superfluid but superfluidity is a consequence of arbitrarily weak repulsive interactions between the atoms. However, in He-4, the interactions between atoms are strong and the system cannot be described using the simple techniques developed above.

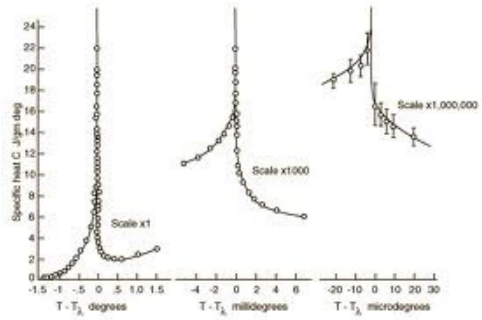

**Figure 22:**  ${}^4\text{He}$ .

Something very similar to Bose condensation also occurs in superconductivity and superfluidity of Helium-3. Now the primary characters are fermions rather than bosons (electrons in the case of superconductivity). As we will see in the next section, fermions cannot condense. But they may form bound states due to interactions and these effective bosons can then undergo condensation.

### 3.6 Fermions

For our final topic, we will discuss the fermion gases. Our analysis will focus solely on non-interacting fermions. Yet this simple model provides a (surprisingly) good first approximation to a wide range of systems, including electrons in metals at low temperatures, liquid Helium-3 and white dwarfs and neutron stars.

Fermions are particles with  $\frac{1}{2}$ -integer spin. By the spin-statistics theorem, the wavefunction of the system is required to pick up a minus sign under exchange of any particle,

$$\psi(\vec{r}_1, \vec{r}_2) = -\psi(\vec{r}_2, \vec{r}_1)$$

As a corollary, the wavefunction vanishes if you attempt to put two identical fermions in the same place. This is a reflection of the *Pauli exclusion principle* which states that fermions cannot sit in the same state. We will see that the low-energy physics of a gas of fermions is entirely dominated by the exclusion principle.

We work again in the grand canonical ensemble. The grand partition function for a single state  $|r\rangle$  is very easy: the state is either occupied or it is not. There is no other option.

$$\mathcal{Z}_r = \sum_{n=0,1} e^{-\beta n(E_r - \mu)} = 1 + e^{-\beta(E_r - \mu)}$$

So, the grand partition function for all states is  $\mathcal{Z} = \prod_r \mathcal{Z}_r$ , from which we can compute the average number of particles in the system

$$N = \sum_r \frac{1}{e^{\beta(E_r - \mu)} + 1} \equiv \sum_r n_r$$

where the average number of particles in the state  $|r\rangle$  is

$$n_r = \frac{1}{e^{\beta(E_r - \mu)} + 1} \quad (3.37)$$

This is the *Fermi-Dirac distribution*. It differs from the Bose-Einstein distribution only by the sign in the denominator. Note however that we had no convergence issues in defining the partition function. Correspondingly, the chemical potential  $\mu$  can be either positive or negative for fermions.

### 3.6.1 Ideal Fermi Gas

We'll look again at non-interacting, non-relativistic particles with  $E = \hbar^2 k^2 / 2m$ . Since fermions necessarily have  $\frac{1}{2}$ -integer spin,  $s$ , there is always a degeneracy factor when counting the number of states given by

$$g_s = 2s + 1$$

For example, electrons have spin  $\frac{1}{2}$  and, correspondingly have a degeneracy of  $g_s = 2$  which just accounts for “spin up” and “spin down” states. We saw similar degeneracy factors when computing the density of states for photons (which have two polarizations) and phonons (which had three). For non-relativistic fermions, the density of states is

$$g(E) = \frac{g_s V}{4\pi^2} \left( \frac{2m}{\hbar^2} \right)^{3/2} E^{1/2}$$

We'll again use the notation of fugacity,  $z = e^{\beta\mu}$ . The particle number is

$$N = \int dE \frac{g(E)}{z^{-1} e^{\beta E} + 1} \quad (3.38)$$

The average energy is

$$E = \int dE \frac{E g(E)}{z^{-1} e^{\beta E} + 1}$$

And the pressure is

$$pV = \frac{1}{\beta} \int dE g(E) \log(1 + z e^{-\beta E}) = \frac{2}{3} E \quad (3.39)$$



At high temperatures, it is simple to repeat the steps of Section 3.5.2. (This is one of the questions on the problem sheet). Only a few minus signs differ along the way and one again finds that for  $z \ll 1$ , the equation of state reduces to that of a classical gas,

$$pV = Nk_B T \left( 1 + \frac{\lambda^3 N}{4\sqrt{2}g_s V} + \dots \right) \quad (3.40)$$

Notice that the minus signs filter down to the final answer: the first quantum correction to a Fermi gas increases the pressure.

### 3.6.2 Degenerate Fermi Gas and the Fermi Surface

In the extreme limit  $T \rightarrow 0$ , the Fermi-Dirac distribution becomes very simple: a state is either filled or empty.

$$\frac{1}{e^{\beta(E-\mu)} + 1} \rightarrow \begin{cases} 1 & \text{for } E < \mu \\ 0 & \text{for } E > \mu \end{cases}$$

It's simple to see what's going on here. Each fermion that we throw into the system settles into the lowest available energy state. These are successively filled until we run out of particles. The energy of the last filled state is called the *Fermi energy* and is denoted as  $E_F$ . Mathematically, it is the value of the chemical potential at  $T = 0$ ,

$$\mu(T = 0) = E_F \quad (3.41)$$

Filling up energy states with fermions is just like throwing balls into a box. With one exception: the energy states of free particles are not localised in position space; they are localised in momentum space. This means that successive fermions sit in states with ever-increasing momentum. In this way, the fermions fill out a ball in momentum space. The momentum of the final fermion is called the *Fermi momentum* and is related to the Fermi energy in the usual way:  $\hbar k_F = (2mE_F)^{1/2}$ . All states with wavevector  $|\vec{k}| \leq k_F$  are filled and are said to form the *Fermi sea* or *Fermi sphere*. Those states with  $|\vec{k}| = k_F$  lie on the edge of the Fermi sea. They are said to form the *Fermi surface*. The concept of a Fermi surface is extremely important in later applications to condensed matter physics.

We can derive an expression for the Fermi energy in terms of the number of particles  $N$  in the system. To do this, we should appreciate that we've actually indulged in a slight abuse of notation when writing (3.41). In the grand canonical ensemble,  $T$  and  $\mu$  are independent variables: they're not functions of each other! What this equation really means is that if we want to keep the average particle number  $N$  in the system

fixed (which we do) then as we vary  $T$  we will have to vary  $\mu$  to compensate. So a slightly clearer way of defining the Fermi energy is to write it directly in terms of the particle number

$$N = \int_0^{E_F} dE g(E) = \frac{g_s V}{6\pi^2} \left( \frac{2m}{\hbar^2} \right)^{3/2} E_F^{3/2} \quad (3.42)$$

Or, inverting,

$$E_F = \frac{\hbar^2}{2m} \left( \frac{6\pi^2 N}{g_s V} \right)^{2/3} \quad (3.43)$$

The Fermi energy sets the energy scale for the system. There is an equivalent temperature scale,  $T_F = E_F/k_B$ . The high temperature expansion that resulted in the equation of state (3.40) is valid at temperatures  $T > T_F$ . In contrast, temperatures  $T < T_F$  are considered “low” temperatures for systems of fermions. Typically, these low temperatures do not have to be too low: for electrons in a metal,  $T_F \sim 10^4 K$ ; for electrons in a white dwarf,  $T_F > 10^7 K$ .

While  $E_F$  is the energy of the last occupied state, the average energy of the system can be easily calculated. It is

$$E = \int_0^{E_F} dE E g(E) = \frac{3}{5} N E_F \quad (3.44)$$

Similarly, the pressure of the degenerate Fermi gas can be computed using (3.39),

$$pV = \frac{2}{5} N E_F \quad (3.45)$$

Even at zero temperature, the gas has non-zero pressure, known as *degeneracy pressure*. It is a consequence of the Pauli exclusion principle and is important in the astrophysics of white dwarf stars and neutron stars. (We will describe this application in Section 3.6.5). The existence of this residual pressure at  $T = 0$  is in stark contrast to both the classical ideal gas (which, admittedly, isn’t valid at zero temperature) and the bosonic quantum gas.

### 3.6.3 The Fermi Gas at Low Temperature

We now turn to the low-temperature behaviour of the Fermi gas. As mentioned above, “low” means  $T \ll T_F$ , which needn’t be particularly low in everyday terms. The number of particles  $N$  and the average energy  $E$  are given by,

$$N = \int_0^\infty dE \frac{g(E)}{z^{-1} e^{\beta E} + 1} \quad (3.46)$$

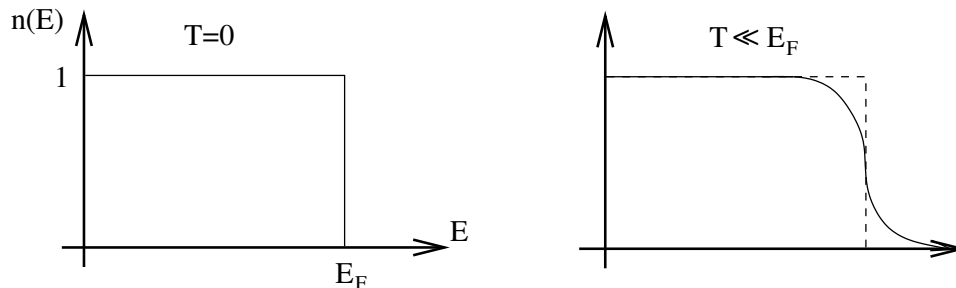

**Figure 23:** The Fermi-Dirac Distribution function at  $T = 0$  and very small  $T$ . The distribution differs from the  $T = 0$  ground state only for a range of energies  $k_B T$  around  $E_F$ .

and

$$E = \int_0^\infty dE \frac{Eg(E)}{z^{-1}e^{\beta E} + 1} \quad (3.47)$$

where, for non-relativistic fermions, the density of states is

$$g(E) = \frac{g_s V}{4\pi^2} \left( \frac{2m}{\hbar^2} \right)^{3/2} E^{1/2}$$

Our goal is to firstly understand how the chemical potential  $\mu$ , or equivalently the fugacity  $z = e^{\beta\mu}$ , changes with temperature when  $N$  is held fixed. From this we can determine how  $E$  changes with temperature when  $N$  is held fixed.

There are two ways to proceed. The first is a direct approach on the problem by Taylor expanding (3.46) and (3.47) for small  $T$ . But it turns out that this is a little delicate because the starting point at  $T = 0$  involves the singular distribution shown on the left-hand side of Figure 23 and it's easy for the physics to get lost in a morass of integrals. For this reason, we start by developing a heuristic understanding of how the integrals (3.46) and (3.47) behave at low temperatures which will be enough to derive the required results. We will then give the more rigorous expansion – sometimes called the *Sommerfeld expansion* – and confirm that our simpler derivation is indeed correct.

The Fermi-Dirac distribution (3.37) at small temperatures is sketched on the right-hand side of Figure 23. The key point is that only states with energy within  $k_B T$  of the Fermi surface are affected by the temperature. We want to insist that as we vary the temperature, the number of particles stays fixed which means that  $dN/dT = 0$ . I claim that this holds if, to leading order, the chemical potential is independent of temperature, so

$$\left. \frac{d\mu}{dT} \right|_{T=0} = 0 \quad (3.48)$$

Let's see why this is the case. The change in particle number can be written as

$$\begin{aligned}\frac{dN}{dT} &= \frac{d}{dT} \int_0^\infty dE \frac{g(E)}{e^{\beta(E-\mu)} + 1} \\ &= \int_0^\infty dE g(E) \frac{d}{dT} \left( \frac{1}{e^{\beta(E-\mu)} + 1} \right) \\ &\approx g(E_F) \int_0^\infty dE \frac{\partial}{\partial T} \left( \frac{1}{e^{\beta(E-E_F)} + 1} \right)\end{aligned}$$

There are two things going on in the step from the second line to the third. Firstly, we are making use of the fact that, for  $k_B T \ll E_F$ , the Fermi-Dirac distribution only changes significantly in the vicinity of  $E_F$  as shown in the right-hand side of Figure 23. This means that the integral in the middle equation above is only receiving contributions in the vicinity of  $E_F$  and we have used this fact to approximate the density of states  $g(E)$  with its value at  $g(E_F)$ . Secondly, we have used our claimed result (3.48) to replace the total derivative  $d/dT$  (which acts on the chemical potential) with the partial derivative  $\partial/\partial T$  (which doesn't) and  $\mu$  is replaced with its zero temperature value  $E_F$ .

Explicitly differentiating the Fermi-Dirac distribution in the final line, we have

$$\frac{dN}{dT} \approx g(E_F) \int_0^\infty dE \left( \frac{E - E_F}{k_B T^2} \right) \frac{1}{4 \cosh^2(\beta(E - E_F)/2)} \approx 0$$

This integral vanishes because  $(E - E_F)$  is odd around  $E_F$  while the cosh function is even. (And, as already mentioned, the integral only receives contributions in the vicinity of  $E_F$ ).

Let's now move on to compute the change in energy with temperature. This, of course, is the heat capacity. Employing the same approximations that we made above, we can write

$$\begin{aligned}C_V &= \left. \frac{\partial E}{\partial T} \right|_{N,V} = \int_0^\infty dE E g(E) \frac{\partial}{\partial T} \left( \frac{1}{e^{\beta(E-\mu)} + 1} \right) \\ &\approx \int_0^\infty dE \left[ E_F g(E_F) + \frac{3}{2} g(E_F) (E - E_f) \right] \frac{\partial}{\partial T} \left( \frac{1}{e^{\beta(E-E_F)} + 1} \right)\end{aligned}$$

However, this time we have not just replaced  $Eg(E)$  by  $E_F g(E_F)$ , but instead Taylor expanded to include a term linear in  $(E - E_F)$ . (The factor of  $3/2$  comes about because  $Eg(E) \sim E^{3/2}$ . The first  $E_F g(E_F)$  term in the square brackets vanishes by the same even/odd argument that we made before. But the  $(E - E_F)$  term survives.

Writing  $x = \beta(E - E_F)$ , the integral becomes

$$C_V \approx \frac{3}{2}g(E_F)T \int_{-\infty}^{\infty} dx \frac{x^2}{4 \cosh^2(x/2)}$$

where we've extended the range of the integral from  $-\infty$  to  $+\infty$ , safe in the knowledge that only the region near  $E_F$  (or  $x = 0$ ) contributes anyway. More importantly, however, this integral only gives an overall coefficient which we won't keep track of. The final result for the heat capacity is

$$C_V \sim T g(E_F)$$

There is a simple way to intuitively understand this linear behaviour. At low temperatures, only fermions within  $k_B T$  of  $E_F$  are participating in the physics. The number of these particles is  $\sim g(E_F)k_B T$ . If each picks up energy  $\sim k_B T$  then the total energy of the system scales as  $E \sim g(E_F)(k_B T)^2$ , resulting in the linear heat capacity found above.

Finally, the heat capacity is often re-expressed in a slightly different form. Using (3.42) we learn that  $N \sim E_F^{3/2}$  which allows us to write,

$$C_V \sim N k_B \left( \frac{T}{T_F} \right) \tag{3.49}$$

### Heat Capacity of Metals

One very important place that we can apply the theory above it to metals. We can try to view the conduction electrons — those which are free to move through the lattice — as an ideal gas. At first glance, this seems very unlikely to work. This is because we are neglecting the Coulomb interaction between electrons. Nonetheless, the ideal gas approximation for electrons turns out to work remarkably well.

From what we've learned in this section, we would expect two contributions to the heat capacity of a metal. The vibrations of the lattice gives a phonon contribution which goes as  $T^3$  (see equation (3.13)). If the conduction electrons act as an ideal gas, they should give a linear term. The low-temperature heat capacity can therefore be written as

$$C_V = \gamma T + \alpha T^3$$

Experimental data is usually plotted as  $C_V/T$  vs  $T^2$  since this gives a straight line which looks nice. The intercept with the  $C_V$  axis tells us the electron contribution. The heat capacity for copper is shown in the figure.

We can get a rough idea of when the phonon and electron contributions to heat capacity are comparable. Equating (3.14) with (3.56), and writing  $24\pi^2/5 \approx 50$ , we have the two contributions are equal when  $T^2 \sim T_D^3/50T_F$ . Ballpark figures are  $T_D \sim 10^2K$  and  $T_F \sim 10^4K$  which tells us that we have to get down to temperatures of around  $1K$  or so to see the electron contribution.

For many metals, the coefficient  $\gamma$  of the linear heat capacity is fairly close to the ideal gas value (within, say, 20% or so). Yet the electrons in a metal are far from free: the Coulomb energy from their interactions is at least as important as the kinetic energy. So why does the ideal gas approximation work so well? This was explained in the 1950s by Landau and the resulting theory — usually called Landau’s Fermi liquid theory — is the basis for our current understanding of electron systems.

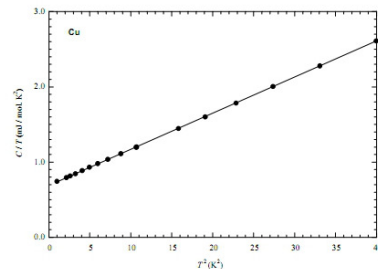

**Figure 24:** The heat capacity of copper (taken from A. Tari “*The Specific Heat of Matter at Low Temperatures*”)

### 3.6.4 A More Rigorous Approach: The Sommerfeld Expansion

The discussion in Section 3.6.3 uses some approximations but highlights the physics of the low-temperature fermi gas. For completeness, here we present a more rigorous derivation of the low-temperature expansion.

To start, we introduce some new notation for the particle number and energy integrals, (3.46) and (3.47). We write,

$$\begin{aligned} \frac{N}{V} &= \frac{g_s}{4\pi^2} \left( \frac{2m}{\hbar^2} \right)^{3/2} \int_0^\infty dE \frac{E^{1/2}}{z^{-1}e^{\beta E} + 1} \\ &= \frac{g_s}{\lambda^3} f_{3/2}(z) \end{aligned} \quad (3.50)$$

and

$$\begin{aligned} \frac{E}{V} &= \frac{g_s}{4\pi^2} \left( \frac{2m}{\hbar^2} \right)^{3/2} \int_0^\infty dE \frac{E^{3/2}}{z^{-1}e^{\beta E} + 1} \\ &= \frac{3}{2} \frac{g_s}{\lambda^3} k_B T f_{5/2}(z) \end{aligned} \quad (3.51)$$

where  $\lambda = \sqrt{2\pi\hbar^2/mk_B T}$  is the familiar thermal wavelength and the functions  $f_n(z)$  are the fermionic analogs of  $g_n$  defined in (3.27),

$$f_n(z) = \frac{1}{\Gamma(n)} \int_0^\infty dx \frac{x^{n-1}}{z^{-1}e^x + 1} \quad (3.52)$$

where it is useful to recall  $\Gamma(3/2) = \sqrt{\pi}/2$  and  $\Gamma(5/2) = 3\sqrt{\pi}/4$  (which follows, of course, from the property  $\Gamma(n+1) = n\Gamma(n)$ ). This function is an example of a polylogarithm and is sometimes written as  $Li_n(-z) = -f_n(z)$ .

### Expanding $f_n(z)$

We will now derive the large  $z$  expansion of  $f_n(z)$ , sometimes called the *Sommerfeld expansion*. The derivation is a little long. We begin by splitting the  $dx$  integral into two parts,

$$\begin{aligned}\Gamma(n)f_n(z) &= \int_0^{\beta\mu} dx \frac{x^{n-1}}{z^{-1}e^x + 1} + \int_{\beta\mu}^{\infty} dx \frac{x^{n-1}}{z^{-1}e^x + 1} \\ &= \int_0^{\beta\mu} dx x^{n-1} \left(1 - \frac{1}{1 + ze^{-x}}\right) + \int_{\beta\mu}^{\infty} dx \frac{x^{n-1}}{z^{-1}e^x + 1} \\ &= \frac{(\log z)^n}{n} - \int_0^{\beta\mu} dx \frac{x^{n-1}}{1 + ze^{-x}} + \int_{\beta\mu}^{\infty} dx \frac{x^{n-1}}{z^{-1}e^x + 1}\end{aligned}$$

We now make a simple change of variable,  $\eta_1 = \beta\mu - x$  for the first integral and  $\eta_2 = x - \beta\mu$  for the second,

$$\Gamma(n)f_n(z) = \frac{(\log z)^n}{n} - \int_0^{\beta\mu} d\eta_1 \frac{(\beta\mu - \eta_1)^{n-1}}{1 + e^{\eta_1}} + \int_0^{\infty} d\eta_2 \frac{(\beta\mu + \eta_2)^{n-1}}{1 + e^{\eta_2}}$$

So far we have only massaged the integral into a useful form. We now make use of the approximation  $\beta\mu \gg 1$ . Firstly, we note that the first integral has a  $e^{\eta_1}$  suppression in the denominator. If we replace the upper limit of the integral by  $\infty$ , the expression changes by a term of order  $e^{-\beta\mu} = z^{-1}$  which is a term we're willing to neglect. With this approximation, we can combine the two integrals into one,

$$\Gamma(n)f_n(z) = \frac{(\log z)^n}{n} + \int_0^{\infty} d\eta \frac{(\beta\mu + \eta)^{n-1} - (\beta\mu - \eta)^{n-1}}{1 + e^{\eta}}$$

We now Taylor expand the numerator,

$$\begin{aligned}(\beta\mu + \eta)^{n-1} - (\beta\mu - \eta)^{n-1} &= (\beta\mu)^{n-1} \left[ (1 + \eta/\beta\mu)^{n-1} - (1 - \eta/\beta\mu)^{n-1} \right] \\ &= (\beta\mu)^{n-1} \left[ 1 + (n-1)\frac{\eta}{\beta\mu} + \dots - 1 + (n-1)\frac{\eta}{\beta\mu} + \dots \right] \\ &= 2(n-1)(\beta\mu)^{n-2}\eta + \dots\end{aligned}$$

From which we get

$$\Gamma(n)f_n(z) = \frac{(\log z)^n}{n} + 2(n-1)(\log z)^{n-2} \int_0^{\infty} d\eta \frac{\eta}{e^{\eta} + 1}$$

We're left with a fairly simple integral.

$$\begin{aligned}
\int_0^\infty d\eta \frac{\eta}{e^\eta + 1} &= \int_0^\infty d\eta \frac{\eta e^{-\eta}}{1 + e^{-\eta}} \\
&= \int_0^\infty d\eta \eta \sum_{m=1}^\infty e^{-m\eta} (-1)^{m+1} \\
&= \sum_{m=1}^\infty \frac{(-1)^{m+1}}{m^2} \int_0^\infty du u e^{-u}
\end{aligned}$$

The integral in the last line is very simple:  $\int_0^\infty du u e^{-u} = 1$ . We have only to do the sum. There are a number of ways to manipulate this. We chose to write

$$\begin{aligned}
1 - \frac{1}{2^2} + \frac{1}{3^2} - \frac{1}{4^2} \dots &= \left(1 + \frac{1}{2^2} + \frac{1}{3^2} + \frac{1}{4^2} + \dots\right) - 2 \left(\frac{1}{2^2} + \frac{1}{4^2} + \frac{1}{6^2} + \dots\right) \\
&= \left(1 - \frac{2}{2^2}\right) \cdot \left(1 + \frac{1}{2^2} + \frac{1}{3^2} + \dots\right)
\end{aligned} \tag{3.53}$$

This final sum is well known. It is  $\sum 1/m^2 = \zeta(2) = \pi^2/6$ . (The original proof of this, by Euler, proceeds by Taylor expanding  $\sin x/x$ , writing resulting sum as a product of roots, and then equating the  $x^2$  term).

After all this work, we finally have the result we want. The low temperature expansion of  $f_n(z)$  is an expansion in  $1/\log z = 1/\beta\mu$ ,

$$f_n(z) = \frac{(\log z)^n}{\Gamma(n+1)} \left(1 + \frac{\pi^2}{6} \frac{n(n-1)}{(\log z)^2} + \dots\right) \tag{3.54}$$

### Back to Physics: Heat Capacity of a Fermi Gas Again

The expansion (3.54) is all we need to determine the leading order effects of temperature on the Fermi gas. The number of particles (3.50) can be expressed in terms of the chemical potential as

$$\frac{N}{V} = \frac{g_s}{6\pi^2\hbar^3} (2m\mu)^{3/2} \left(1 + \frac{\pi^2}{8} \left(\frac{k_B T}{\mu}\right)^2 + \dots\right) \tag{3.55}$$

But the number of particles determines the Fermi energy through (3.43). For fixed particle number  $N$ , we can therefore express the chemical potential at finite temperature in terms of the Fermi energy. After a small amount of algebra, we find

$$\mu = E_F \left(1 - \frac{\pi^2}{12} \left(\frac{k_B T}{E_F}\right)^2 + \dots\right)$$



We see that the chemical potential is a maximum at  $T = 0$  and decreases at higher  $T$ . This is to be expected: recall that by the time we get to the classical gas, the chemical potential must be negative. Moreover, note that the leading order correction is quadratic in temperature rather than linear, in agreement with our earlier claim (3.48).

The energy density can be computed from (3.51) and (3.54). It is

$$\frac{E}{V} = \frac{g_s}{10\pi^2\hbar^3}(2m)^{3/2}\mu^{5/2} \left( 1 + \frac{5\pi^2}{8} \left( \frac{k_B T}{\mu} \right)^2 + \dots \right)$$

Our real interest is in the heat capacity. However, with fixed particle number  $N$ , the chemical potential also varies with temperature at quadratic order. We can solve this problem by dividing by (3.55) to get

$$\frac{E}{N} = \frac{3E_F}{5} \left( 1 + \frac{5\pi^2}{12} \left( \frac{k_B T}{E_F} \right)^2 + \dots \right)$$

Now the only thing that depends on temperature on the right-hand side is  $T$  itself. From this we learn that the heat capacity of a low temperature Fermi gas is linear in  $T$ ,

$$C_V = \left. \frac{\partial E}{\partial T} \right|_{N,V} = Nk_B \frac{\pi^2}{2} \frac{T}{T_F} \quad (3.56)$$

But we now have the correct coefficient that completes our earlier result (3.49).

### 3.6.5 White Dwarfs and the Chandrasekhar limit

When stars exhaust their fuel, the temperature  $T \rightarrow 0$  and they have to rely on the Pauli exclusion principle to support themselves through the degeneracy pressure (3.45). Such stars supported by electron degeneracy pressure are called white dwarfs. In addition to the kinetic energy  $E_{\text{kinetic}}$  of fermions given in (3.43) the system has gravitational energy. If we make the further assumption that the density in a star of radius  $R$  is uniform, then

$$E_{\text{grav}} = -\frac{3}{5} \frac{G_N M^2}{R}$$

where  $G_N$  is Newton's constant. In the problem set, you will minimise  $E_{\text{grav}} + E_{\text{kinetic}}$  to find the relationship between the radius and mass of the star,

$$R \sim M^{-1/3}$$

This is unusual. Normally if you throw some stuff on a pile, the pile gets bigger. Not so for stars supported by degeneracy pressure. The increased gravitational attraction wins and causes them to shrink.

As the star shrinks, the Fermi energy (3.43) grows. Eventually it becomes comparable to the electron mass  $m_e$  and our non-relativistic approximation breaks down. We can redo our calculations using the relativistic formula for the density of states (3.4) (which needs to be multiplied by a factor of 2 to account for the spin degeneracy). In the opposite regime of ultra-relativistic electrons, where  $E \gg m_e$ , then we can expand the density of states as

$$g(E) = \frac{V}{\pi^2 \hbar^3 c^3} \left( E^2 - \frac{m^2 c^4}{2} + \dots \right)$$

from which we can determine the kinetic energy due to fermions, replacing the non-relativistic result (3.44) by

$$E_{\text{kinetic}} = \frac{V}{\pi^2 \hbar^3 c^3} \left( \frac{1}{4} E_F^4 - \frac{m^2 c^4}{4} E_F^2 + \dots \right)$$

The Fermi energy can be expressed in terms of the particle number by

$$N = \frac{V}{\pi^2 \hbar^3 c^3} \left( \frac{1}{3} E_F^3 - \frac{m^2 c^4}{2} E_F + \dots \right)$$

The total energy of the system is then given by,

$$E_{\text{grav}} + E_F = \left[ \frac{3\hbar c}{4} \left( \frac{9\pi M^4}{4m_p^4} \right)^{1/3} - \frac{3}{5} G_N M^2 \right] \frac{1}{R} + \mathcal{O}(R)$$

where  $m_p$  is the proton mass (and we're taking  $M = Nm_p$  as a good approximation to the full mass of the star). If the term above is positive then the star once again settles into a minimum energy state, where the  $1/R$  term balances the term that grows linearly in  $R$ . But if the  $1/R$  term is negative, we have a problem: the star is unstable to gravitational collapse and will shrink to smaller and smaller values of  $R$ . This occurs when the mass exceeds the *Chandrasekhar limit*,  $M > M_C$ . Neglecting factors of 2 and  $\pi$ , this limit is

$$M_C \sim \left( \frac{\hbar c}{G_N} \right)^{3/2} \frac{1}{m_p^2} \quad (3.57)$$

This is roughly 1.5 times the mass of the Sun. Stars that exceed this bound will not end their life as white dwarfs. Their collapse may ultimately be stopped by degeneracy pressure of neutrons so that they form a neutron star. Or it may not be stopped at all in which case they form a black hole.

The factor in brackets in (3.57) is an interesting mix of fundamental constants associated to quantum theory, relativity and gravity. In this combination, they define a mass scale called the Planck mass,

$$M_{pl}^2 = \frac{\hbar c}{G_N}$$

When energy densities reach the Planck scale, quantum gravity effects are important meaning that we have to think of quantising spacetime itself. We haven't quite reached this limit in white dwarf stars. (We're shy by about 25 orders of magnitude or so!). Nonetheless the presence of the Planck scale in the Chandra limit is telling us that both quantum effects and gravitational effects are needed to understand white dwarf stars: the matter is quantum; the gravity is classical.

### 3.6.6 Pauli Paramagnetism

“With heavy heart, I have decided that Fermi-Dirac, not Einstein, is the correct statistics, and I have decided to write a short note on paramagnetism”

*Wolfgang Pauli, in a letter to Schrödinger, reluctantly admitting that electrons are fermions*

We now describe a gas of electrons in a background magnetic field  $\vec{B}$ . There are two effects that are important: the Lorentz force  $\vec{v} \times B$  on the motion of electrons and the coupling of the electron spin to the magnetic field. We first discuss the spin coupling and postpone the Lorentz force for the next section.

An electron can have two spin states, “up” and “down”. We'll denote the spin state by a discrete label:  $s = 1$  for spin up;  $s = -1$  for spin down. In a background magnetic field  $\vec{B}$ , the kinetic energy picks up an extra term

$$E_{\text{spin}} = \mu_B B s \tag{3.58}$$

where  $\mu_B = |e|\hbar/2mc$  is the Bohr magneton. (It has nothing to do with the chemical potential. Do not confuse them!)

Since spin up and spin down electrons have different energies, their occupation numbers differ. Equation (3.50) is now replaced by

$$\begin{aligned} \frac{N_{\uparrow}}{V} &= \frac{1}{4\pi^2} \left( \frac{2m}{\hbar^2} \right)^{3/2} \int_0^{\infty} dE \frac{E^{1/2}}{e^{\beta(E+\mu_B B-\mu)} + 1} = \frac{1}{\lambda^3} f_{3/2}(ze^{+\beta\mu_B B}) \\ \frac{N_{\downarrow}}{V} &= \frac{1}{4\pi^2} \left( \frac{2m}{\hbar^2} \right)^{3/2} \int_0^{\infty} dE \frac{E^{1/2}}{e^{\beta(E-\mu_B B-\mu)} + 1} = \frac{1}{\lambda^3} f_{3/2}(ze^{-\beta\mu_B B}) \end{aligned}$$

Our interest is in computing the *magnetization*, which is a measure of how the energy of the system responds to a magnetic field,

$$M = \frac{\partial E}{\partial B} \quad (3.59)$$

Since each spin has energy (3.58), the magnetization is simply the difference in the number of up spins and down spins,

$$M = \mu_B(N_\uparrow - N_\downarrow) = \frac{\mu_B V}{\lambda^3} [f_{3/2}(ze^{\beta\mu_B B}) - f_{3/2}(ze^{-\beta\mu_B B})]$$

At high temperatures, and suitably low magnetic fields, we can approximate  $f_{3/2}(z) \approx z$  as  $z \rightarrow 0$ , so that

$$M \approx \frac{2\mu_B V z}{\lambda^3} \sinh(\beta\mu_B B)$$

We can eliminate the factor of  $z$  in favour of the particle number,

$$N = N_\uparrow + N_\downarrow \approx \frac{2Vz}{\lambda^3} \cosh(\beta\mu_B B)$$

From which we can determine the high temperature magnetization,

$$M \approx \mu_B N \tanh(\beta\mu_B B)$$

This is the same result that you computed in the first problem sheet using the simple two-state model. We see that, once again, at high temperatures the quantum statistics are irrelevant. The magnetic susceptibility is a measure of how easy it is to magnetise a substance. It is defined as

$$\chi \equiv \frac{\partial M}{\partial B} \quad (3.60)$$

Evaluating  $\chi$  in the limit of vanishing magnetic field, we find that the magnetization is inversely proportional to the temperature,

$$\chi(B=0) = \frac{N\mu_B^2}{k_B T}$$

This  $1/T$  behaviour is known as *Curie's law*. (Pierre, not Marie).

The above results hold in the high temperature limit. In contrast, at low temperatures the effects of the Fermi surface become important. We need only keep the leading order term in (3.54) to find

$$M \approx \frac{\mu_B V}{6\pi^2} \left( \frac{2m}{\hbar^2} \right)^{3/2} [(E_F + \mu_B B)^{3/2} - (E_F - \mu_B B)^{3/2}] \approx \frac{\mu_B^2 V}{2\pi^2} \left( \frac{2m}{\hbar^2} \right)^{3/2} E_F^{1/2} B$$

where we've written the final result in the limit  $\mu_B B \ll E_F$  and expanded to linear order in  $B$ . We could again replace some of the factors for the electron number  $N$ . However, we can emphasise the relevant physics slightly better if we write the result above in terms of the density of states (3.19). Including the factor of 2 for spin degeneracy, we have

$$M \approx \mu_B^2 g(E_F) B \quad (3.61)$$

We see that at low temperatures, the magnetic susceptibility no longer obeys Curie's law, but saturates to a constant

$$\chi \equiv \frac{\partial M}{\partial B} = \mu_B^2 g(E_F)$$

What's happening here is that most electrons are embedded deep within the Fermi surface and the Pauli exclusion principle forbids them from flipping their spins in response to a magnetic field. Only those electrons that sit on the Fermi surface itself — all  $g(E_F)$  of them — have the luxury to save energy by aligning their spins with the magnetic field.

Notice that  $\chi > 0$ . Such materials are called paramagnetic: in the presence of a magnetic field, the magnetism increases. Materials that are paramagnetic are attracted to applied magnetic fields. The effect described above is known as *Pauli paramagnetism*.

### 3.6.7 Landau Diamagnetism

For charged fermions, such as electrons, there is a second consequence of placing them in a magnetic field: they move in circles. The Hamiltonian describing a particle of charge  $-e$  in a magnetic field  $\vec{B} = \nabla \times \vec{A}$  is,

$$H = \frac{1}{2m} \left( \vec{p} + \frac{e}{c} \vec{A}(\vec{r}) \right)^2$$

This has an immediate consequence: a magnetic field cannot affect the statistical physics of a classical gas! This follows simply from substituting the above Hamiltonian into the classical partition function (2.1). A simple shift of variables,  $\vec{p}' = \vec{p} + e\vec{A}/c$  shows that the classical partition function does not depend on  $\vec{B}$ . This result (which was also mentioned in a slightly different way in the *Classical Dynamics* course) is known as the Bohr-van Leeuwen theorem: it states that there can be no classical magnetism.

Let's see how quantum effects change this conclusion. Our first goal is to understand the one-particle states for an electron in a constant background magnetic field. This is a problem that you will also solve in the *Applications of Quantum Mechanics* course. It is the problem of Landau levels.

## Landau Levels

We will consider an electron moving in a constant magnetic field pointing in the  $\hat{z}$  direction:  $\vec{B} = (0, 0, B)$ . There are many different ways to pick  $\vec{A}$  such that  $\vec{B} = \nabla \times \vec{A}$  gives the right magnetic field. These are known as *gauge choices*. Each choice will give rise to the same physics but, usually, very different equations in the intervening steps. Here we make the following gauge choice,

$$\vec{A} = (-By, 0, 0) \quad (3.62)$$

Let's place our particle in a cubic box with sides of length  $L$ . Solutions to the Schrödinger equation  $\hat{H}\psi = E\psi$  are simply plane waves in the  $x$  and  $z$  directions,

$$\psi(\vec{r}) = e^{i(k_x x + k_z z)} f(y)$$

But the wavefunction  $f(y)$  must satisfy,

$$\left[ -\frac{\hbar^2}{2m} \frac{\partial^2}{\partial y^2} + \frac{1}{2m} \left( \hbar k_x - \frac{e}{c} B y \right)^2 \right] f(y) = E' f(y) \quad (3.63)$$

But this is a familiar equation! If we define the *cyclotron frequency*,

$$\omega_c = \frac{eB}{mc}$$

Then we can rewrite (3.63) as

$$\left[ -\frac{\hbar^2}{2m} \frac{\partial^2}{\partial y^2} + \frac{1}{2} m \omega_c^2 (y - y_0)^2 \right] f(y) = E' f(y)$$

where  $y_0 = \hbar k_x c / eB$ . This is simply the Schrödinger equation for a harmonic oscillator, jiggling with frequency  $\omega_c$  and situated at position  $y_0$ .

One might wonder why the harmonic oscillator appeared. The cyclotron frequency  $\omega_c$  is the frequency at which electrons undergo classical Larmor orbits, so that kind of makes sense. But why have these become harmonic oscillators sitting at positions  $y_0$  which depend on  $k_x$ ? The answer is that there is no deep meaning to this at all! it is merely an artifact of our gauge choice (3.62). Had we picked a different  $\vec{A}$  giving rise to

the same  $\vec{B}$ , we would find ourselves trying to answer a different question! The lesson here is that when dealing with gauge potentials, the intermediate steps of a calculation do not always have physical meaning. Only the end result is important. Let's see what this is. The energy of the particle is

$$E = E' + \frac{\hbar^2 k_z^2}{2m}$$

where  $E'$  is the energy of the harmonic oscillator,

$$E' = \left(n + \frac{1}{2}\right) \hbar\omega_c \quad n \in \mathbf{Z}$$

These discrete energy levels are known as *Landau levels*. They are highly degenerate. To see this, note that  $k_x$  is quantized in unit of  $\Delta k_x = 2\pi/L$ . This means that we can have a harmonic oscillator located every  $\Delta y_0 = 2\pi\hbar c/eBL$ . The number of such oscillators that we can fit into the box of size  $L$  is  $L/\Delta y_0$ . This is the degeneracy of each level,

$$\frac{eBL^2}{2\pi\hbar c} \equiv \frac{\Phi}{\Phi_0}$$

where  $\Phi = L^2B$  is the total flux through the system and  $\Phi_0 = 2\pi\hbar c/e$  is known as the *flux quantum*. (Note that the result above does not include a factor of 2 for the spin degeneracy of the electron).

### Back to the Diamagnetic Story

We can now compute the grand partition function for non-interacting electrons in a magnetic field. Including the factor of 2 from electron spin, we have

$$\log \mathcal{Z} = \frac{L}{2\pi} \int dk_z \sum_{n=0}^{\infty} \frac{2L^2B}{\Phi_0} \log \left[ 1 + z \exp \left( -\frac{\beta\hbar^2 k_z^2}{2m} - \beta\hbar\omega_c(n + 1/2) \right) \right]$$

To perform the sum, we use the Euler summation formula which states that for any function  $h(x)$ ,

$$\sum_{n=0}^{\infty} h(n + 1/2) = \int_0^{\infty} h(x) dx + \frac{1}{24} h'(0) + \dots$$

We'll apply the Euler summation formula to the function,

$$h(x) = \int dk_z \log \left[ 1 + \exp \left( -\frac{\beta\hbar^2 k_z^2}{2m} + \beta x \right) \right]$$

So the grand partition function becomes

$$\begin{aligned}
\log \mathcal{Z} &= \frac{VB}{\pi\Phi_0} \sum_{n=0}^{\infty} h(\mu - \hbar\omega_c(n + 1/2)) \\
&= \frac{VB}{\pi\Phi_0} \int_0^{\infty} h(\mu - \hbar\omega_c x) dx - \frac{VB}{\pi\Phi_0} \frac{\hbar\omega_c}{24} \frac{dh(\mu)}{d\mu} + \dots \\
&= \frac{Vm}{2\pi^2\hbar^2} \left[ \int_{-\infty}^{\mu} h(y) dy - \frac{(\hbar\omega_c)^2}{24} \int_{-\infty}^{+\infty} dk \frac{\beta}{e^{\beta(\hbar^2 k^2/2m - \mu)} + 1} \right] + \dots \quad (3.64)
\end{aligned}$$

The first term above does not depend on  $B$ . In fact it is simply a rather perverse way of writing the partition function of a Fermi gas when  $B = 0$ . However, our interest here is in the magnetization which is again defined as (3.59). In the grand canonical ensemble, this is simply

$$M = \frac{1}{\beta} \frac{\partial \log \mathcal{Z}}{\partial B}$$

The second term in (3.64) is proportional to  $B^2$  (which is hiding in the  $\omega_c^2$  term). Higher order terms in the Euler summation formula will carry higher powers of  $B$  and, for small  $B$ , the expression above will suffice.

At  $T = 0$ , the integrand is simply 1 for  $|k| < k_F$  and zero otherwise. To compare to Pauli paramagnetism, we express the final result in terms of the Bohr magneton  $\mu_B = |e|\hbar/2mc$ . We find

$$M = -\frac{\mu_B^2}{3} g(E_F) B$$

This is comparable to the Pauli contribution (3.61). But it has opposite sign. Substances whose magnetization is opposite to the magnetic field are called *diamagnetic*: they are repelled by applied magnetic fields. The effect that we have derived above is known as *Landau diamagnetism*.



## 4. Classical Thermodynamics

“Thermodynamics is a funny subject. The first time you go through it, you don’t understand it at all. The second time you go through it, you think you understand it, except for one or two small points. The third time you go through it, you know you don’t understand it, but by that time you are used to it, so it doesn’t bother you any more.”

*Arnold Sommerfeld, making excuses*

So far we’ve focussed on a statistical mechanics, studying systems in terms of their microscopic constituents. In this section, we’re going to take a step back and look at classical thermodynamics. This is a theory that cares nothing for atoms and microscopics. Instead it describes relationships between the observable macroscopic phenomena that we see directly.

In some sense, returning to thermodynamics is a retrograde step. It is certainly not as fundamental as the statistical description. Indeed, the “laws” of thermodynamics that we describe below can all be derived from statistical physics. Nonetheless, there are a number of reasons for developing classical thermodynamics further.

First, pursuing classical thermodynamics will give us a much deeper understanding of some of the ideas that briefly arose in Section 1. In particular, we will focus on how energy flows due to differences in temperature. Energy transferred in this way is called *heat*. Through a remarkable series of arguments involving heat, one can deduce the existence of a quantity called entropy and its implications for irreversibility in the Universe. This definition of entropy is entirely equivalent to Boltzmann’s later definition  $S = k_B \log \Omega$  but makes no reference to the underlying states.

Secondly, the weakness of thermodynamics is also its strength. Because the theory is ignorant of the underlying nature of matter, it is limited in what it can tell us. But this means that the results we deduce from thermodynamics are not restricted to any specific system. They will apply equally well in any circumstance, from biological systems to quantum gravity. And you can’t say that about a lot of theories!

In Section 1, we briefly described the first and second laws of thermodynamics as consequences of the underlying principles of statistical physics. Here we instead place ourselves in the shoes of Victorian scientists with big beards, silly hats and total ignorance of atoms. We will present the four laws of thermodynamics as axioms on which the theory rests.

## 4.1 Temperature and the Zeroth Law

We need to start with a handful of definitions:

- A system that is completely isolated from all outside influences is said to be contained in *adiabatic walls*. We will also refer to such systems as *insulated*.
- Walls that are not adiabatic are said to be *diathermal* and two systems separated by a diathermal wall are said to be in *thermal contact*. A diathermal wall is still a wall which means that it neither moves, nor allows particles to transfer from one system to the other. However, it is not in any other way special and it will allow heat (to be defined shortly) to be transmitted between systems. If in doubt, think of a thin sheet of metal.
- An isolated system, when left alone for a suitably long period of time, will relax to a state where no further change is noticeable. This state is called *equilibrium*.

Since we care nothing for atoms and microstates, we must use macroscopic variables to describe any system. For a gas, the only two variables that we need to specify are pressure  $p$  and volume  $V$ : if you know the pressure and volume, then all other quantities — colour, smell, viscosity, thermal conductivity — are fixed. For other systems, further (or different) variables may be needed to describe their macrostate. Common examples are surface tension and area for a film; magnetic field and magnetization for a magnet; electric field and polarization for a dielectric. In what follows we'll assume that we're dealing with a gas and use  $p$  and  $V$  to specify the state. Everything that we say can be readily extended to more general settings.

So far, we don't have a definition of temperature. This is provided by the zeroth law of thermodynamics which states that equilibrium is a transitive property,

**Zeroth Law:** If two systems,  $A$  and  $B$ , are each in equilibrium with a third body  $C$ , then they are also in equilibrium with each other

Let's see why this allows us to define the concept of temperature. Suppose that system  $A$  is in state  $(p_1, V_1)$  and  $C$  is in state  $(p_3, V_3)$ . To test if the two systems are in equilibrium, we need only place them in thermal contact and see if their states change. For generic values of pressure and volume, we will find that the systems are not in equilibrium. Equilibrium requires some relationship between the  $(p_1, V_1)$  and  $(p_3, V_3)$ . For example, suppose that we choose  $p_1, V_1$  and  $p_3$ , then there will be a special value of  $V_3$  for which nothing happens when the two systems are brought together.

We'll write the constraint that determines when  $A$  and  $C$  are in equilibrium as

$$F_{AC}(p_1, V_1; p_3, V_3) = 0$$

which can be solved to give

$$V_3 = f_{AC}(p_1, V_1; p_3)$$

Since systems  $B$  and  $C$  are also in equilibrium, we also have a constraint,

$$F_{BC}(p_2, V_2; p_3, V_3) = 0 \quad \Rightarrow \quad V_3 = f_{BC}(p_2, V_2; p_3)$$

These two equilibrium conditions give us two different expressions for the volume  $V_3$ ,

$$f_{AC}(p_1, V_1; p_3) = f_{BC}(p_2, V_2; p_3) \tag{4.1}$$

At this stage we invoke the zeroth law, which tells us that systems  $A$  and  $B$  must also be in equilibrium, meaning that (4.1) must be equivalent to a constraint

$$F_{AB}(p_1, V_1; p_2, V_2) = 0 \tag{4.2}$$

Equation (4.1) implies (4.2), but the latter does not depend on  $p_3$ . That means that  $p_3$  must appear in (4.1) in such a way that it can just be cancelled out on both sides. When this cancellation is performed, (4.1) tells us that there is a relationship between system the states of system  $A$  and system  $B$ .

$$\theta_A(p_1, V_1) = \theta_B(p_2, V_2)$$

The value of  $\theta(p, V)$  is called the *temperature* of the system. The function  $T = \theta(p, V)$  is called the *equation of state*.

The above argument really only tells us that there exists a property called temperature. There's nothing yet to tell us why we should pick  $\theta(p, V)$  as temperature rather than, say  $\sqrt{\theta(p, V)}$ . We will shortly see that there is, in fact, a canonical choice of temperature that is defined through the second law of thermodynamics and a construct called the Carnot cycle. However, in the meantime it will suffice to simply pick a reference system to define temperature. The standard choice is the ideal gas equation of state (which, as we have seen, is a good approximation to real gases at low densities),

$$T = \frac{pV}{Nk_B}$$

## 4.2 The First Law

The first law is simply the statement of the conservation of energy, together with the tacit acknowledgement that there's more than one way to change the energy of the system. It is usually expressed as something along the lines of

**First Law:** The amount of work required to change an *isolated* system from state 1 to state 2 is independent of how the work is performed.

This rather cumbersome sentence is simply telling us that there is another function of state of the system,  $E(P, V)$ . This is the energy. We could do an amount of work  $W$  on an isolated system in any imaginative way we choose: squeeze it, stir it, place a wire and resistor inside with a current passing through it. The method that we choose does not matter: in all cases, the change of the energy is  $\Delta E = W$ .

However, for systems that are not isolated, the change of energy is *not* equal to the amount of work done. For example, we could take two systems at different temperatures and place them in thermal contact. We needn't do any work, but the energy of each system will change. We're forced to accept that there are other ways to change the energy of the system than by doing work. We write

$$\Delta E = Q + W \tag{4.3}$$

where  $Q$  is the amount of energy that was transferred to the system that can't be accounted for by the work done. This transfer of energy arises due to temperature differences. It is called *heat*.

Heat is *not* a type of energy. It is a process — a mode of transfer of energy. There is no sense in which we can divide up the energy  $E(p, V)$  of the system into heat and work. We can't write " $E = Q + W$ " because neither  $Q$  nor  $W$  are functions of state.

### Quasi-Static Processes

In the discussion above, the transfer of energy can be as violent as you like. There is no need for the system to be in equilibrium while the energy is being added: the first law as expressed in (4.3) refers only to energy at the beginning and end.

From now on, we will be more gentle. We will add or subtract energy to the system very slowly, so that at every stage of the process the system is effectively in equilibrium and can be described by the thermodynamic variables  $p$  and  $V$ . Such a process is called *quasi-static*.

For quasi-static processes, it is useful to write (4.3) in infinitesimal form. Unfortunately, this leads to a minor notational headache. The problem is that we want to retain the distinction between  $E(p, V)$ , which is a function of state, and  $Q$  and  $W$ , which are not. This means that an infinitesimal change in the energy is a total derivative,

$$dE = \frac{\partial E}{\partial p} dp + \frac{\partial E}{\partial V} dV$$

while an infinitesimal amount of work or heat has no such interpretation: it is merely something small. To emphasise this, it is common to make up some new notation<sup>7</sup>. A small amount of heat is written  $\bar{d}Q$  and a small amount of work is written  $\bar{d}W$ . The first law of thermodynamics in infinitesimal form is then

$$dE = \bar{d}Q + \bar{d}W \quad (4.4)$$

Although we introduced the first law as applying to all types of work, from now on the discussion is simplest if we just restrict to a single method to applying work to a system: squeezing. We already saw in Section 1 that the infinitesimal work done on a system is

$$\bar{d}W = -pdV$$

which is the same thing as “force  $\times$  distance”. Notice the sign convention. When  $\bar{d}W > 0$ , we are doing work on the system by squeezing it so that  $dV < 0$ . However, when the system expands,  $dV > 0$  so  $\bar{d}W < 0$  and the system is performing work.

Expressing the work as  $\bar{d}W = -pdV$  also allows us to underline the meaning of the new symbol  $\bar{d}$ . There is no function  $W(p, V)$  which has “ $dW = -pdV$ ”. (For example, you could try  $W = -pV$  but that gives  $dW = -pdV - Vdp$  which isn’t what we want). The notation  $\bar{d}W$  is there to remind us that work is not an exact differential.

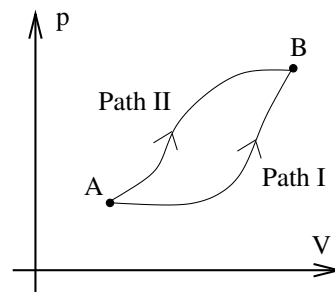

**Figure 25:**

Suppose now that we vary the state of a system through two different quasi-static paths as shown in the figure. The change in energy is independent of the path taken: it is  $\int dE = E(p_2, V_2) - E(p_1, V_1)$ . In contrast, the work done  $\int \bar{d}W = -\int pdV$  depends on the path taken. This simple observation will prove important for our next discussion.

<sup>7</sup>In a more sophisticated language,  $dE$ ,  $\bar{d}W$  and  $\bar{d}Q$  are all one-forms on the state space of the system.  $dE$  is exact;  $\bar{d}W$  and  $\bar{d}Q$  are not.

### 4.3 The Second Law

“Once or twice I have been provoked and have asked company how many of them could describe the Second Law of Thermodynamics, the law of entropy. The response was cold: it was also negative. Yet I was asking something which is about the scientific equivalent of: ‘Have you read a work of Shakespeare?’ ”

*C.P.Snow (1959)*

C.P. Snow no doubt had in mind the statement that entropy increases. Yet this is a consequence of the second law; it is not the axiom itself. Indeed, we don’t yet even have a thermodynamic definition of entropy.

The essence of the second law is that there is a preferred direction of time. There are many macroscopic processes in Nature which cannot be reversed. Things fall apart. The lines on your face only get deeper. Words cannot be unsaid. The second law summarises all such observations in a single statements about the motion of heat.

#### Reversible Processes

Before we state the second law, it will be useful to first focus on processes which can happily work in both directions of time. These are a special class of quasi-static processes that can be run backwards. They are called *reversible*

A reversible process must lie in equilibrium at each point along the path. This is the quasi-static condition. But now there is the further requirement that there is no friction involved.

For reversible processes, we can take a round trip as shown to the right. Start in state  $(p_1, V_1)$ , take the lower path to  $(p_2, V_2)$  and then the upper path back to  $(p_1, V_1)$ . The energy is unchanged because  $\oint dE = 0$ . But the total work done is non-zero:  $\oint pdV \neq 0$ . By the first law of thermodynamics (4.4), the work performed by the system during the cycle must be equal to the heat absorbed by the system,  $\oint \bar{d}Q = \oint pdV$ . If we go one way around the cycle, the system does work and absorbs heat from the surroundings; the other way round work is done on the system which then emits energy as heat.

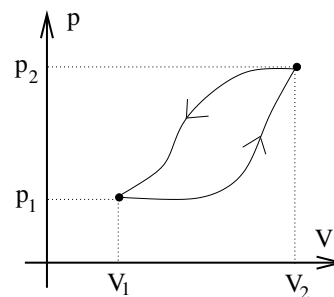

**Figure 26:**

Processes which move in a cycle like this, returning to their original starting point, are interesting. Run the right way, they convert heat into work. But that's very very useful. The work can be thought of as a piston which can be used to power a steam train. Or a playstation. Or an LHC.

### The Statement of the Second Law

The second law is usually expressed in one of two forms. The first tells us when energy can be fruitfully put to use. The second emphasises the observation that there is an arrow of time in the macroscopic world: heat flows from hot to cold. They are usually stated as

**Second Law à la Kelvin:** No process is possible whose sole effect is to extract heat from a hot reservoir and convert this entirely into work

**Second Law à la Clausius:** No process is possible whose sole effect is the transfer of heat from a colder to hotter body

It's worth elaborating on the meaning of these statements. Firstly, we all have objects in our kitchens which transfer heat from a cold environment to a hot environment: this is the purpose of a fridge. Heat is extracted from inside the fridge where it's cold and deposited outside where it's warm. Why doesn't this violate Clausius' statement? The reason lies in the words "sole effect". The fridge has an extra effect which is to make your electricity meter run up. In thermodynamic language, the fridge operates because we're supplying it with "work". To get the meaning of Clausius' statement, think instead of a hot object placed in contact with a cold object. Energy always flows from hot to cold; never the other way round.

The statements by Kelvin and Clausius are equivalent. Suppose, for example, that we build a machine that violates Kelvin's statement by extracting heat from a hot reservoir and converting it entirely into work. We can then use this work to power a fridge, extracting heat from a cold source and depositing it back into a hot source. The combination of the two machines then violates Clausius's statement. It is not difficult to construct a similar argument to show that "not Clausius"  $\Rightarrow$  "not Kelvin".

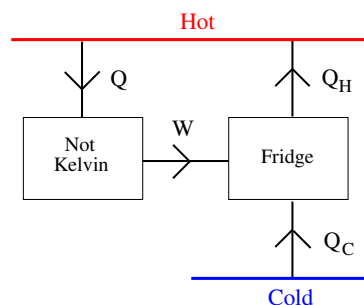

**Figure 27:**

Our goal in this Section is to show how these statements of the second law allow us to define a quantity called "entropy".

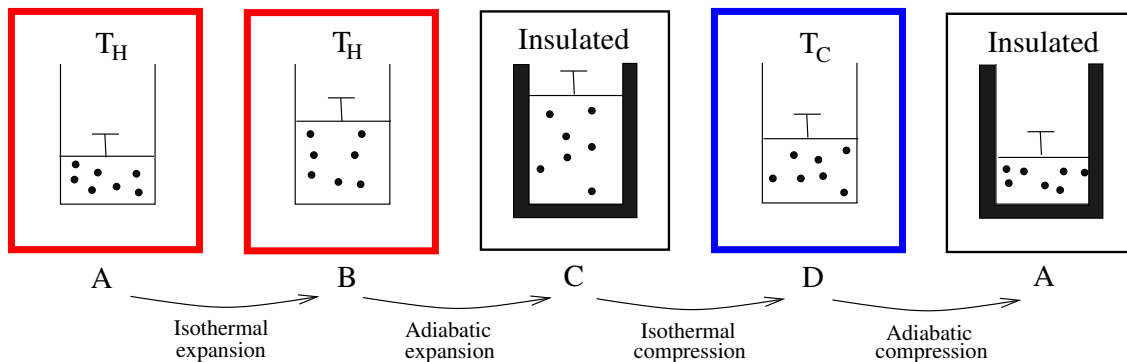

**Figure 28:** The Carnot cycle in cartoon.

### 4.3.1 The Carnot Cycle

Kelvin's statement of the second law is that we can't extract heat from a hot reservoir and turn it entirely into work. Yet, at first glance, this appears to be in contrast with what we know about reversible cycles. We have just seen that these necessarily have  $\oint \bar{d}Q = \oint \bar{d}W$  and so convert heat to work. Why is this not in contradiction with Kelvin's statement?

The key to understanding this is to appreciate that a reversible cycle does more than just extract heat from a hot reservoir. It also, by necessity, deposits some heat elsewhere. The energy available for work is the difference between the heat extracted and the heat lost. To illustrate this, it's very useful to consider a particular kind of reversible cycle called a *Carnot engine*. This is series of reversible processes, running in a cycle, operating between two temperatures  $T_H$  and  $T_C$ . It takes place in four stages shown in cartoon in Figures 28 and 29.

- Isothermal expansion  $AB$  at a constant hot temperature  $T_H$ . The gas pushes against the side of its container and is allowed to slowly expand. In doing so, it can be used to power your favourite electrical appliance. To keep the temperature constant, the system will need to absorb an amount of heat  $Q_H$  from the surroundings
- Adiabatic expansion  $BC$ . The system is now isolated, so no heat is absorbed. But the gas is allowed to continue to expand. As it does so, both the pressure and temperature will decrease.
- Isothermal contraction  $CD$  at constant temperature  $T_C$ . We now start to restore the system to its original state. We do work on the system by compressing the



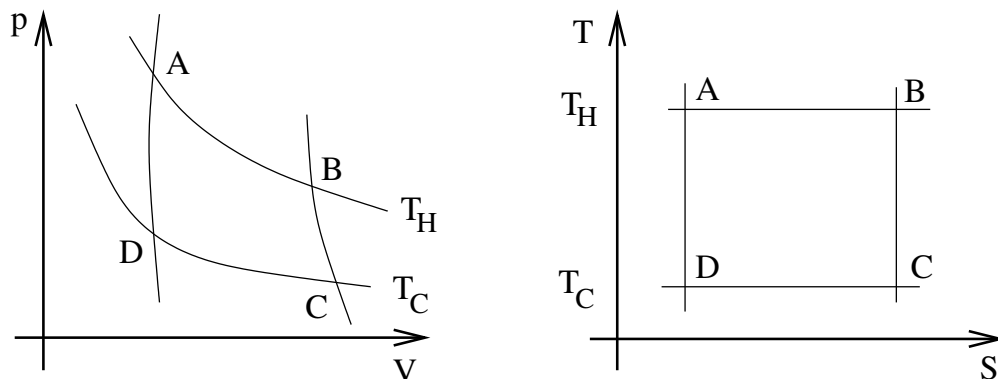

**Figure 29:** The Carnot cycle, shown in the  $p - V$  plane and the  $T - S$  plane.

gas. If we were to squeeze an isolated system, the temperature would rise. But we keep the system at fixed temperature, so it dumps heat  $Q_C$  into its surroundings.

- Adiabatic contraction  $DA$ . We isolate the gas from its surroundings and continue to squeeze. Now the pressure and temperature both increase. We finally reach our starting point when the gas is again at temperature  $T_H$ .

At the end of the four steps, the system has returned to its original state. The net heat absorbed is  $Q_H - Q_C$  which must be equal to the work performed by the system  $W$ . We define the *efficiency*  $\eta$  of an engine to be the ratio of the work done to the heat absorbed from the hot reservoir,

$$\eta = \frac{W}{Q_H} = \frac{Q_H - Q_C}{Q_H} = 1 - \frac{Q_C}{Q_H}$$

Ideally, we would like to take all the heat  $Q_H$  and convert it to work. Such an engine would have efficiency  $\eta = 1$  but would be in violation of Kelvin's statement of the second law. We can see the problem in the Carnot cycle: we have to deposit some amount of heat  $Q_C$  back to the cold reservoir as we return to the original state. And the following result says that the Carnot cycle is the best we can do:

**Carnot's Theorem:** Carnot is the best. Or, more precisely: Of all engines operating between two heat reservoirs, a reversible engine is the most efficient. As a simple corollary, all reversible engines have the same efficiency which depends only on the temperatures of the reservoirs  $\eta(T_H, T_C)$ .

**Proof:** Let's consider a second engine — call it Ivor — operating between the same two temperatures  $T_H$  and  $T_C$ . Ivor also performs work  $W$  but, in contrast to Carnot, is not reversible. Suppose that Ivor absorbs  $Q'_H$  from the hot reservoir and deposits  $Q'_C$  into the cold. Then we can couple Ivor to our original Carnot engine set to reverse.

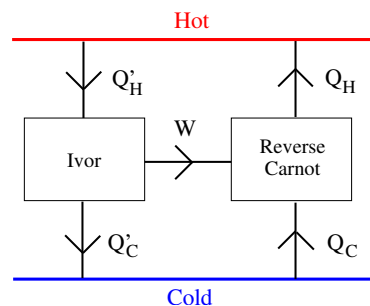

**Figure 30:**

The work  $W$  performed by Ivor now goes into driving Carnot. The net effect of the two engines is to extract  $Q'_H - Q_H$  from the hot reservoir and, by conservation of energy, to deposit the same amount  $Q'_C - Q_C = Q'_H - Q_H$  into the cold. But Clausius's statement tells us that we must have  $Q'_H \geq Q_H$ ; if this were not true, energy would be moved from the colder to hotter body. Performing a little bit of algebra then gives

$$Q'_C - Q'_H = Q_C - Q_H \quad \Rightarrow \quad \eta_{\text{Ivor}} = 1 - \frac{Q'_C}{Q'_H} = \frac{Q_H - Q_C}{Q'_H} \leq \frac{Q_H - Q_C}{Q_H} = \eta_{\text{Carnot}}$$

The upshot of this argument is the result that we wanted, namely

$$\eta_{\text{Carnot}} \geq \eta_{\text{Ivor}}$$

The corollary is now simple to prove. Suppose that Ivor was reversible after all. Then we could use the same argument above to prove that  $\eta_{\text{Ivor}} \geq \eta_{\text{Carnot}}$ , so it must be true that  $\eta_{\text{Ivor}} = \eta_{\text{Carnot}}$  if Ivor is reversible. This means that for all reversible engines operating between  $T_H$  and  $T_C$  have the same efficiency. Or, said another way, the ratio  $Q_H/Q_C$  is the same for all reversible engines. Moreover, this efficiency must be a function only of the temperatures,  $\eta_{\text{Carnot}} = \eta(T_H, T_C)$ , simply because they are the only variables in the game.  $\square$ .

### 4.3.2 Thermodynamic Temperature Scale and the Ideal Gas

Recall that the zeroth law of thermodynamics showed that there was a function of state, which we call temperature, defined so that it takes the same value for any two systems in equilibrium. But at the time there was no canonical way to decide between different definitions of temperature:  $\theta(p, V)$  or  $\sqrt{\theta(p, V)}$  or any other function are all equally good choices. In the end we were forced to pick a reference system — the ideal gas — as a benchmark to define temperature. This was a fairly arbitrary choice. We can now do better.

Since the efficiency of a Carnot engine depends only on the temperatures  $T_H$  and  $T_C$ , we can use this to define a temperature scale that is independent of any specific material. (Although, as we shall see, the resulting temperature scale turns out to be equivalent to the ideal gas temperature). Let's now briefly explain how we can define a temperature through the Carnot cycle.

The key idea is to consider two Carnot engines. The first operates between two temperature reservoirs  $T_1 > T_2$ ; the second engine operates between two reservoirs  $T_2 > T_3$ . If the first engine extracts heat  $Q_1$  then it must dump heat  $Q_2$  given by

$$Q_2 = Q_1 (1 - \eta(T_1, T_2))$$

where the arguments above tell us that  $\eta = \eta_{\text{Carnot}}$  is a function only of  $T_1$  and  $T_2$ . If the second engine now takes this same heat  $Q_2$ , it must dump heat  $Q_3$  into the reservoir at temperature  $T_3$ , given by

$$Q_3 = Q_2 (1 - \eta(T_2, T_3)) = Q_1 (1 - \eta(T_1, T_2)) (1 - \eta(T_2, T_3))$$

But we can also consider both engines working together as a Carnot engine in its own right, operating between reservoirs  $T_1$  and  $T_3$ . Such an engine extracts heat  $Q_1$ , dumps heat  $Q_3$  and has efficiency  $\eta(T_1, T_3)$ , so that

$$Q_3 = Q_1 (1 - \eta(T_1, T_3))$$

Combining these two results tells us that the efficiency must be a function which obeys the equation

$$1 - \eta(T_1, T_3) = (1 - \eta(T_1, T_2)) (1 - \eta(T_2, T_3))$$

The fact that  $T_2$  has to cancel out on the right-hand side is enough to tell us that

$$1 - \eta(T_1, T_2) = \frac{f(T_2)}{f(T_1)}$$

for some function  $f(T)$ . At this point, we can use the ambiguity in the definition of temperature to simply pick a nice function, namely  $f(T) = T$ . Hence, we *define* the thermodynamic temperature to be such that the efficiency is given by

$$\eta = 1 - \frac{T_2}{T_1} \tag{4.5}$$

## The Carnot Cycle for an Ideal Gas

We now have two ways to specify temperature. The first arises from looking at the equation of state of a specific, albeit simple, system: the ideal gas. Here temperature is defined to be  $T = pV/Nk_B$ . The second definition of temperature uses the concept of Carnot cycles. We will now show that, happily, these two definitions are equivalent by explicitly computing the efficiency of a Carnot engine for the ideal gas.

We deal first with the isothermal changes of the ideal gas. We know that the energy in the gas depends only on the temperature<sup>8</sup>,

$$E = \frac{3}{2}Nk_B T \quad (4.6)$$

So  $dT = 0$  means that  $dE = 0$ . The first law then tells us that  $\bar{d}Q = -\bar{d}W$ . For the motion along the line  $AB$  in the Carnot cycle, we have

$$Q_H = \int_A^B \bar{d}Q = - \int_A^B \bar{d}W = \int_A^B p dV = \int_A^B \frac{Nk_B T_H}{V} dV = Nk_B T_H \log \left( \frac{V_B}{V_A} \right) \quad (4.7)$$

Similarly, the heat given up along the line  $CD$  in the Carnot cycle is

$$Q_C = -Nk_B T_C \log \left( \frac{V_D}{V_C} \right) \quad (4.8)$$

Next we turn to the adiabatic change in the Carnot cycle. Since the system is isolated,  $\bar{d}Q = 0$  and all work goes into the energy,  $dE = -pdV$ . Meanwhile, from (4.6), we can write the change of energy as  $dE = C_V dT$  where  $C_V = \frac{3}{2}Nk_B$ , so

$$C_V dT = -\frac{Nk_B T}{V} dV \quad \Rightarrow \quad \frac{dT}{T} = -\left( \frac{Nk_B}{C_V} \right) \frac{dV}{V}$$

After integrating, we have

$$TV^{2/3} = \text{constant}$$

---

<sup>8</sup>A confession: strictly speaking, I'm using some illegal information in the above argument. The result  $E = \frac{3}{2}Nk_B T$  came from statistical mechanics and if we're really pretending to be Victorian scientists we should discuss the efficiency of the Carnot cycle without this knowledge. Of course, we could just measure the heat capacity  $C_V = \partial E / \partial T|_V$  to determine  $E(T)$  experimentally and proceed. Alternatively, and more mathematically, we could note that it's not necessary to use this exact form of the energy to carry through the argument: we need only use the fact that the energy is a function of temperature only:  $E = E(T)$ . The isothermal parts of the Carnot cycle are trivially the same and we reproduce (4.7) and (4.8). The adiabatic parts cannot be solved exactly without knowledge of  $E(T)$  but you can still show that  $V_A/V_B = V_D/V_C$  which is all we need to derive the efficiency (4.9).

Applied to the line  $BC$  and  $DA$  in the Carnot cycle, this gives

$$T_H V_B^{2/3} = T_C V_C^{2/3} \quad , \quad T_C V_D^{2/3} = T_H V_A^{2/3}$$

which tells us that  $V_A/V_B = V_D/V_C$ . But this means that the factors of  $\log(V/V)$  cancel when we take the ratio of heats. The efficiency of a Carnot engine for an ideal gas — and hence for any system — is given by

$$\eta_{\text{carnot}} = 1 - \frac{Q_C}{Q_H} = 1 - \frac{T_C}{T_H} \tag{4.9}$$

We see that the efficiency using the ideal gas temperature coincides with our thermodynamic temperature (4.5) as advertised.

### 4.3.3 Entropy

The discussion above was restricted to Carnot cycles: reversible cycles operating between two temperatures. The second law tells us that we can't turn all the extracted heat into work. We have to give some back. To generalize, let's change notation slightly so that  $Q$  always denotes the energy absorbed by the system. If the system releases heat, then  $Q$  is negative. In terms of our previous notation,  $Q_1 = Q_H$  and  $Q_2 = -Q_C$ . Similarly,  $T_1 = T_H$  and  $T_2 = T_C$ . Then, for all Carnot cycles

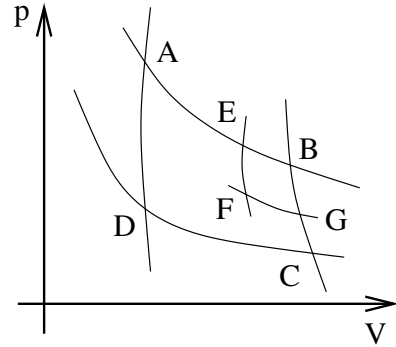

Figure 31:

$$\sum_{i=1}^2 \frac{Q_i}{T_i} = 0$$

Now consider the reversible cycle shown in the figure in which we cut the corner of the original cycle. From the original Carnot cycle  $ABCD$ , we know that

$$\frac{Q_{AB}}{T_H} + \frac{Q_{CD}}{T_C} = 0$$

Meanwhile, we can view the square  $EBGF$  as a mini-Carnot cycle so we also have

$$\frac{Q_{GF}}{T_{FG}} + \frac{Q_{EB}}{T_H} = 0$$

What if we now run along the cycle  $AEFGCD$ ? Clearly  $Q_{AB} = Q_{AE} + Q_{EB}$ . But we also know that the heat absorbed along the segment  $FG$  is equal to that dumped along

the segment  $GF$  when we ran the mini-Carnot cycle. This follows simply because we're taking the same path but in the opposite direction and tells us that  $Q_{FG} = -Q_{GF}$ . Combining these results with the two equations above gives us

$$\frac{Q_{AE}}{T_H} + \frac{Q_{FG}}{T_{FG}} + \frac{Q_{CD}}{T_C} = 0$$

By cutting more and more corners, we can consider any reversible cycle as constructed of (infinitesimally) small isothermal and adiabatic segments. Summing up all contributions  $Q/T$  along the path, we learn that the total heat absorbed in any reversible cycle must obey

$$\oint \frac{\bar{d}Q}{T} = 0$$

But this is a very powerful statement. It means that if we reversibly change our system from state  $A$  to state  $B$ , then the quantity  $\int_A^B \bar{d}Q/T$  is independent of the path taken. Either of the two paths shown in the figure will give the same result:

$$\int_{\text{Path I}} \frac{\bar{d}Q}{T} = \int_{\text{Path II}} \frac{\bar{d}Q}{T}$$

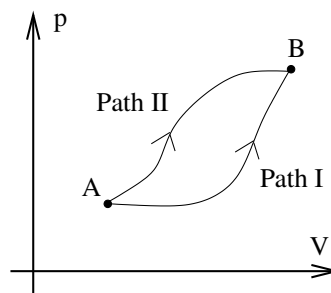

**Figure 32:**

Given some reference state  $O$ , this allows us to define a new function of state. It is called *entropy*,  $S$

$$S(A) = \int_0^A \frac{\bar{d}Q}{T} \tag{4.10}$$

Entropy depends only on the state of the system:  $S = S(p, V)$ . It does not depend on the path we took to get to the state. We don't even have to take a reversible path: as long as the system is in equilibrium, it has a well defined entropy (at least relative to some reference state).

We have made no mention of microstates in defining the entropy. Yet it is clearly the same quantity that we met in Section 1. From (4.10), we can write  $dS = \bar{d}Q/T$ , so that the first law of thermodynamics (4.4) is written in the form of (1.16)

$$dE = TdS - pdV \tag{4.11}$$

## Irreversibility

What can we say about paths that are not reversible? By Carnot's theorem, we know that an irreversible engine that operates between two temperatures  $T_H$  and  $T_C$  is less efficient than the Carnot cycle. We use the same notation as in the proof of Carnot's theorem; the Carnot engine extracts heat  $Q_H$  and dumps heat  $Q_C$ ; the irreversible engine extracts heat  $Q'_H$  and dumps  $Q'_C$ . Both do the same amount of work  $W = Q_H - Q_C = Q'_H - Q'_C$ . We can then write

$$\begin{aligned} \frac{Q'_H}{T_H} - \frac{Q'_C}{T_C} &= \frac{Q_H}{T_H} - \frac{Q_C}{T_C} + (Q'_H - Q_H) \left( \frac{1}{T_H} - \frac{1}{T_C} \right) \\ &= (Q'_H - Q_H) \left( \frac{1}{T_H} - \frac{1}{T_C} \right) \leq 0 \end{aligned}$$

In the second line, we used  $Q_H/T_H = Q_C/T_C$  for a Carnot cycle, and to derive the inequality we used the result of Carnot's theorem, namely  $Q'_H \geq Q_H$  (together with the fact that  $T_H > T_C$ ).

The above result holds for any engine operating between two temperatures. But by the same method of cutting corners off a Carnot cycle that we used above, we can easily generalise the statement to any path, reversible or irreversible. Putting the minus signs back in so that heat dumped has the opposite sign to heat absorbed, we arrive at a result is known as the *Clausius inequality*,

$$\oint \frac{\delta Q}{T} \leq 0$$

We can express this in slightly more familiar form. Suppose that we have two possible paths between states  $A$  and  $B$  as shown in the figure. Path I is irreversible while path II is reversible. Then Clausius's inequality tells us that

$$\begin{aligned} \oint \frac{\delta Q}{T} &= \int_I \frac{\delta Q}{T} - \int_{II} \frac{\delta Q}{T} \leq 0 \\ \Rightarrow \int_I \frac{\delta Q}{T} &\leq S(B) - S(A) \end{aligned} \quad (4.12)$$

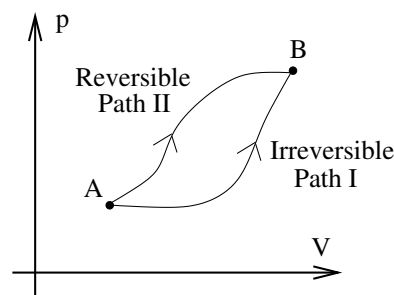

**Figure 33:**

Suppose further that path I is adiabatic, meaning that it is isolated from the environment. Then  $\delta Q = 0$  and we learn that the entropy of any isolated system never decreases,

$$S(B) \geq S(A) \quad (4.13)$$

Moreover, if an adiabatic process is reversible, then the resulting two states have equal entropy.

The second law, as expressed in (4.13), is responsible for the observed arrow of time in the macroscopic world. Isolated systems can only evolve to states of equal or higher entropy. This coincides with the statement of the second law that we saw back in Section 1.2.1 using Boltzmann's definition of the entropy.

#### 4.3.4 Adiabatic Surfaces

The primary consequence of the second law is that there exists a new function of state, entropy. Surfaces of constant entropy are called *adiabatic surfaces*. The states that sit on a given adiabatic surface can all be reached by performing work on the system while forbidding any heat to enter or leave. In other words, they are the states that can be reached by adiabatic processes with  $\vec{d}Q = 0$  which is equivalent to  $dS = 0$ .

In fact, for the simplest systems such as the ideal gas which require only two variables  $p$  and  $V$  to specify the state, we do not need the second law to infer to the existence of an adiabatic surface. In that case, the adiabatic surface is really an adiabatic line in the two-dimensional space of states. The existence of this line follows immediately from the first law. To see this, we write the change of energy for an adiabatic process using (4.4) with  $\vec{d}Q = 0$ ,

$$dE + pdV = 0 \tag{4.14}$$

Let's view the energy itself as a function of  $p$  and  $V$  so that we can write

$$dE = \frac{\partial E}{\partial p} dp + \frac{\partial E}{\partial V} dV$$

Then the condition for an adiabatic process (4.14) becomes

$$\frac{\partial E}{\partial p} dp + \left( \frac{\partial E}{\partial V} + p \right) dV = 0$$

Which tells us the slope of the adiabatic line is given by

$$\frac{dp}{dV} = - \left( \frac{\partial E}{\partial V} + p \right) \left( \frac{\partial E}{\partial p} \right)^{-1} \tag{4.15}$$

The upshot of this calculation is that if we sit in a state specified by  $(p, V)$  and transfer work but no heat to the system then we necessarily move along a line in the space of states determined by (4.15). If we want to move off this line, then we have to add heat to the system.



However, the analysis above does not carry over to more complicated systems where more than two variables are needed to specify the state. Suppose that the state of the system is specified by three variables. The first law of thermodynamics is now gains an extra term, reflecting the fact that there are more ways to add energy to the system,

$$dE = \bar{d}Q - pdV - ydX$$

We've already seen examples of this with  $y = -\mu$ , the chemical potential, and  $X = N$ , the particle number. Another very common example is  $y = -M$ , the magnetization, and  $X = H$ , the applied magnetic field. For our purposes, it won't matter what variables  $y$  and  $X$  are: just that they exist. We need to choose three variables to specify the state. Any three will do, but we will choose  $p$ ,  $V$  and  $X$  and view the energy as a function of these:  $E = E(p, V, X)$ . An adiabatic process now requires

$$dE + pdV + ydX = 0 \quad \Rightarrow \quad \frac{\partial E}{\partial p} dp + \left( \frac{\partial E}{\partial V} + p \right) dV + \left( \frac{\partial E}{\partial X} + y \right) dX = 0 \quad (4.16)$$

But this equation does not necessarily specify a surface in  $\mathbf{R}^3$ . To see that this is not sufficient, we can look at some simple examples. Consider  $\mathbf{R}^3$ , parameterised by  $z_1$ ,  $z_2$  and  $z_3$ . If we move in an infinitesimal direction satisfying

$$z_1 dz_1 + z_2 dz_2 + z_3 dz_3 = 0$$

then it is simple to see that we can integrate this equation to learn that we are moving on the surface of a sphere,

$$z_1^2 + z_2^2 + z_3^2 = \text{constant}$$

In contrast, if we move in an infinitesimal direction satisfying the condition

$$z_2 dz_1 + dz_2 + dz_3 = 0 \quad (4.17)$$

Then there is no associated surface on which we're moving. Indeed, you can convince yourself that if you move in a such a way as to always obey (4.17) then you can reach any point in  $\mathbf{R}^3$  from any other point.

In general, an infinitesimal motion in the direction

$$Z_1 dz_1 + Z_2 dz_2 + Z_3 dz_3 = 0$$

has the interpretation of motion on a surface only if the functions  $Z_i$  obey the condition

$$Z_1 \left( \frac{\partial Z_2}{\partial z_3} - \frac{\partial Z_3}{\partial z_2} \right) + Z_2 \left( \frac{\partial Z_3}{\partial z_1} - \frac{\partial Z_1}{\partial z_3} \right) + Z_3 \left( \frac{\partial Z_1}{\partial z_2} - \frac{\partial Z_2}{\partial z_1} \right) = 0 \quad (4.18)$$

So for systems with three or more variables, the existence of an adiabatic surface is not guaranteed by the first law alone. We need the second law. This ensures the existence of a function of state  $S$  such that adiabatic processes move along surfaces of constant  $S$ . In other words, the second law tells us that (4.16) satisfies (4.18).

In fact, there is a more direct way to infer the existence of adiabatic surfaces which uses the second law but doesn't need the whole rigmarole of Carnot cycles. We will again work with a system that is specified by three variables, although the argument will hold for any number. But we choose our three variables to be  $V$ ,  $X$  and the internal energy  $E$ . We start in state  $A$  shown in the figure. We will show that Kelvin's statement of the second law implies that it is not possible to reach both states  $B$  and  $C$  through reversible adiabatic processes. The key feature of these states is that they have the same values of  $V$  and  $X$  and differ only in their energy  $E$ .

To prove this statement, suppose the converse: i.e. we can indeed reach both  $B$  and  $C$  from  $A$  through means of reversible adiabatic processes. Then we can start at  $A$  and move to  $B$ . Since the energy is lowered, the system performs work along this path but, because the path is adiabatic, no heat is exchanged. Now let's move from  $B$  to  $C$ . Because  $dV = dX = 0$  on this trajectory, we do no work but the internal energy  $E$  changes so the system must absorb heat  $Q$  from the surroundings. Now finally we do work on the system to move from  $C$  back to  $A$ . However, unlike in the Carnot cycle, we don't return any heat to the environment on this return journey because, by assumption, this second path is also adiabatic. The net result is that we have extracted heat  $Q$  and employed this to undertake work  $W = Q$ . This is in contradiction with Kelvin's statement of the second law.

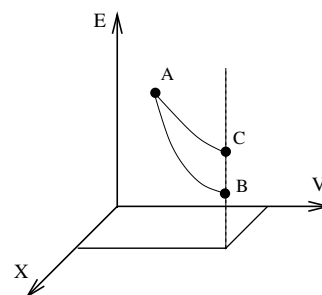

**Figure 34:**

The upshot of this argument is that the space of states can be foliated by adiabatic surfaces such that each vertical line at constant  $V$  and  $X$  intersects the surface only once. We can describe these surfaces by some function  $S(E, V, X) = \text{constant}$ . This function is the entropy.

The above argument shows that Kelvin's statement of the second law implies the existence of adiabatic surfaces. One may wonder if we can run the argument the other way around and use the existence of adiabatic surfaces as the basis of the second law, dispensing with the Kelvin and Clausius postulates all together. In fact, we can almost do this. From the discussion above it should already be clear that the existence of

adiabatic surfaces implies that the addition of heat is proportional to the change in entropy  $\delta Q \sim dS$ . However, it remains to show that the integrating factor, relating the two, is temperature so  $\delta Q = TdS$ . This can be done by returning to the zeroth law of thermodynamics. A fairly simple description of the argument can be found at the end of Chapter 4 of Pippard's book. This motivates a mathematically concise statement of the second law due to Carathéodory.

**Second Law à la Carathéodory:** Adiabatic surfaces exist. Or, more prosaically: if you want to be able to return, there are places you cannot go through work alone. Sometimes you need a little heat.

What this statement is lacking is perhaps the most important aspect of the second law: an arrow of time. But this is easily remedied by providing one additional piece of information telling us which side of a surface can be reached by irreversible processes. To one side of the surface lies the future, to the other the past.

#### 4.3.5 A History of Thermodynamics

The history of heat and thermodynamics is long and complicated, involving wrong turns, insights from disparate areas of study such as engineering and medicine, and many interesting characters, more than one of which find reason to change their name at some point in the story<sup>9</sup>.

Although ideas of what heat is date back to pre-history, a good modern starting point is the 1787 *caloric* theory of Lavoisier. This postulates that heat is a conserved fluid which has a tendency to repel itself, thereby flowing from hot bodies to cold bodies. It was, for its time, an excellent theory, explaining many of the observed features of heat. Of course, it was also wrong.

Lavoisier's theory was still prominent 30 years later when the French engineer Sadi Carnot undertook the analysis of steam engines that we saw above. Carnot understood all of his processes in terms of caloric. He was inspired by mechanics of waterwheels and saw the flow of caloric from hot to cold bodies as analogous to the fall of water from high to low. This work was subsequently extended and formalised in a more mathematical framework by another French physicist, Émile Clapeyron. By the 1840s, the properties of heat were viewed by nearly everyone through the eyes of Carnot-Clapeyron caloric theory.

---

<sup>9</sup>A longer description of the history of heat can be found in Michael Fowler's lectures from the University of Virginia: <http://galileo.phys.virginia.edu/classes/152.mf1i.spring02/HeatIndex.htm>

Yet the first cracks in caloric theory has already appeared before the turn of 19th century due to the work of Benjamin Thompson. Born in the English colony of Massachusetts, Thompson's CV includes turns as mercenary, scientist and humanitarian. He is the inventor of thermal underwear and pioneer of the soup kitchen for the poor. By the late 1700s, Thompson was living in Munich under the glorious name "Count Rumford of the Holy Roman Empire" where he was charged with overseeing artillery for the Prussian Army. But his mind was on loftier matters. When boring cannons, Rumford was taken aback by the amount of heat produced by friction. According to Lavoisier's theory, this heat should be thought of as caloric fluid squeezed from the brass cannon. Yet it seemed inexhaustible: when a cannon was bored a second time, there was no loss in its ability to produce heat. Thompson/Rumford suggested that the cause of heat could not be a conserved caloric. Instead he attributed heat correctly, but rather cryptically, to "motion".

Having put a big dent in Lavoisier's theory, Rumford rubbed salt in the wound by marrying his widow. Although, in fairness, Lavoisier was beyond caring by this point. Rumford was later knighted by Britain, reverting to Sir Benjamin Thompson, where he founded the Royal Institution.

The journey from Thompson's observation to an understanding of the first law of thermodynamics was a long one. Two people in particular take the credit.

In Manchester, England, James Joule undertook a series of extraordinarily precise experiments. He showed how different kinds of work — whether mechanical or electrical — could be used to heat water. Importantly, the amount by which the temperature was raised depended only on the amount of work, not the manner in which it was applied. His 1843 paper "The Mechanical Equivalent of Heat" provided compelling quantitative evidence that work could be readily converted into heat.

But Joule was apparently not the first. A year earlier, in 1842, the German physician Julius von Mayer came to the same conclusion through a very different avenue of investigation: blood letting. Working on a ship in the Dutch East Indies, Mayer noticed that the blood in sailors veins was redder in Germany. He surmised that this was because the body needed to burn less fuel to keep warm. Not only did he essentially figure out how the process of oxidation is responsible for supplying the body's energy but, remarkably, he was able to push this an understanding of how work and heat are related. Despite limited physics training, he used his intuition, together with known experimental values of the heat capacities  $C_p$  and  $C_V$  of gases, to determine essentially the same result as Joule had found through more direct means.

The results of Thompson, Mayer and Joule were synthesised in an 1847 paper by Hermann von Helmholtz, who is generally credited as the first to give a precise formulation of the first law of thermodynamics. (Although a guy from Swansea called William Grove has a fairly good, albeit somewhat muddled, claim from a few years earlier). It's worth stressing the historical importance of the first law: this was the first time that the conservation of energy was elevated to a key idea in physics. Although it had been known for centuries that quantities such as " $\frac{1}{2}mv^2 + V$ " were conserved in certain mechanical problems, this was often viewed as a mathematical curiosity rather than a deep principle of Nature. The reason, of course, is that friction is important in most processes and energy does not appear to be conserved. The realisation that there is a close connection between energy, work and heat changed this. However, it would still take more than half a century before Emmy Noether explained the true reason behind the conservation of tenergy.

With Helmholtz, the first law was essentially nailed. The second remained. This took another two decades, with the pieces put together by a number of people, notably William Thomson and Rudolph Clausius.

William Thomson was born in Belfast but moved to Glasgow at the age of 10. He came to Cambridge to study, but soon returned to Glasgow and stayed there for the rest of his life. After his work as a scientist, he gained fame as an engineer, heavily involved in laying the first trans-atlantic cables. For this he was made Lord Kelvin, the name chosen for the River Kelvin which flows nearby Glasgow University. He was the first to understand the importance of absolute zero and to define the thermodynamic temperature scale which now bears his favourite river's name. We presented Kelvin's statement of the second law of thermodynamics earlier in this Section.

In Germany, Rudolph Clausius was developing the same ideas as Kelvin. But he managed to go further and, in 1865, presented the subtle thermodynamic argument for the existence of entropy that we saw in Section 4.3.3. Modestly, Clausius introduced the unit "Clausius" (symbol **Cl**) for entropy. It didn't catch on.

#### 4.4 Thermodynamic Potentials: Free Energies and Enthalpy

We now have quite a collection of thermodynamic variables. The state of the system is dictated by pressure  $p$  and volume  $V$ . From these, we can define temperature  $T$ , energy  $E$  and entropy  $S$ . We can also mix and match. The state of the system can just as well be labelled by  $T$  and  $V$ ; or  $E$  and  $V$ ; or  $T$  and  $p$ ; or  $V$  and  $S$  . . .

While we're at liberty to pick any variables we like, certain quantities are more naturally expressed in terms of some variables instead of others. We've already seen examples both in Section 1 and in this section. If we're talking about the energy  $E$ , it is best to label the state in terms of  $S$  and  $V$ , so  $E = E(S, V)$ . In these variables the first law has the nice form (4.11).

Equivalently, inverting this statement, the entropy should be thought of as a function of  $E$  and  $V$ , so  $S = S(E, V)$ . It is not just mathematical niceties underlying this: it has physical meaning too for, as we've seen above, at fixed energy the second law tells us that entropy can never decrease.

What is the natural object to consider at constant temperature  $T$ , rather than constant energy? In fact we already answered this way back in Section 1.3 where we argued that one should minimise the Helmholtz free energy,

$$F = E - TS$$

The arguments that we made back in Section 1.3 were based on a microscopic viewpoint of entropy. But, with our thermodynamic understanding of the second law, we can easily now repeat the argument without mention of probability distributions. We consider our system in contact with a heat reservoir such that the total energy,  $E_{\text{total}}$  of the combined system and reservoir is fixed. The combined entropy is then,

$$\begin{aligned} S_{\text{total}}(E_{\text{total}}) &= S_R(E_{\text{total}} - E) + S(E) \\ &\approx S_R(E_{\text{total}}) - \frac{\partial S_R}{\partial E_{\text{total}}} E + S(E) \\ &= S_R(E_{\text{total}}) - \frac{F}{T} \end{aligned}$$

The total entropy can never decrease; the free energy of the system can never increase.

One interesting situation that we will meet in the next section is a system which, at fixed temperature and volume, has two different equilibrium states. Which does it choose? The answer is the one that has lower free energy, for random thermal fluctuations will tend to take us to this state, but very rarely bring us back.

We already mentioned in Section 1.3 that the free energy is a Legendre transformation of the energy; it is most naturally thought of as a function of  $T$  and  $V$ , which is reflected in the infinitesimal variation,

$$dF = -SdT - pdV \quad \Rightarrow \quad \left. \frac{\partial F}{\partial T} \right|_V = -S \quad , \quad \left. \frac{\partial F}{\partial V} \right|_T = -p \quad (4.19)$$

We can now also explain what's free about this energy. Consider taking a system along a reversible isotherm, from state  $A$  to state  $B$ . Because the temperature is constant, the change in free energy is  $dF = -pdV$ , so

$$F(B) - F(A) = - \int_A^B pdV = -W$$

where  $W$  is the work done by the system. The free energy is a measure of the amount of energy free to do work at finite temperature.

### Gibbs Free Energy

We can also consider systems that don't live at fixed volume, but instead at fixed pressure. To do this, we will once again imagine the system in contact with a reservoir at temperature  $T$ . The volume of each can fluctuate, but the total volume  $V_{\text{total}}$  of the combined system and reservoir is fixed. The total entropy is

$$\begin{aligned} S_{\text{total}}(E_{\text{total}}, V_{\text{total}}) &= S_R(E_{\text{total}} - E, V_{\text{total}} - V) + S(E, V) \\ &\approx S_R(E_{\text{total}}, V_{\text{total}}) - \frac{\partial S_R}{\partial E_{\text{total}}} E - \frac{\partial S_R}{\partial V_{\text{total}}} V + S(E, V) \\ &= S_R(V_{\text{total}}) - \frac{E + pV - TS}{T} \end{aligned}$$

At fixed temperature and pressure we should minimise the *Gibbs Free Energy*,

$$G = F + pV = E + pV - TS \quad (4.20)$$

This is a Legendre transform of  $F$ , this time swapping volume for pressure:  $G = G(T, p)$ . The infinitesimal variation is

$$dG = -SdT + Vdp$$

In our discussion we have ignored the particle number  $N$ . Yet both  $F$  and  $G$  implicitly depend on  $N$  (as you may check by re-examining the many examples of  $F$  that we computed earlier in the course). If we also consider changes  $dN$  then each variations gets the additional term  $\mu dN$ , so

$$dF = -SdT - pdV + \mu dN \quad \text{and} \quad dG = -SdT + Vdp + \mu dN \quad (4.21)$$

While  $F$  can have an arbitrarily complicated dependence on  $N$ , the Gibbs free energy  $G$  has a very simple dependence. To see this, we simply need to look at the extensive properties of the different variables and make the same kind of argument that we've already seen in Section 1.4.1. From its definition (4.20), we see that the Gibbs free

energy  $G$  is extensive. It is a function of  $p$ ,  $T$  and  $N$ , of which only  $N$  is extensive. Therefore,

$$G(p, T, N) = \mu(p, T)N \quad (4.22)$$

where the fact that the proportionality coefficient is  $\mu$  follows from variation (4.21) which tells us that  $\partial G/\partial N = \mu$ .

The Gibbs free energy is frequently used by chemists, for whom reactions usually take place at constant pressure rather than constant volume. (When a chemist talks about “free energy”, they usually mean  $G$ . For a physicist, “free energy” usually means  $F$ ). We’ll make use of the result (4.22) in the next section when we discuss first order phase transitions.

#### 4.4.1 Enthalpy

There is one final combination that we can consider: systems at fixed energy and pressure. Such systems are governed by the *enthalpy*,

$$H = E + pV \quad \Rightarrow \quad dH = TdS + Vdp$$

The four objects  $E$ ,  $F$ ,  $G$  and  $H$  are sometimes referred to as *thermodynamic potentials*.

#### 4.4.2 Maxwell’s Relations

Each of the thermodynamic potentials has an interesting present for us. Let’s start by considering the energy. Like any function of state, it can be viewed as a function of any of the other two variables which specify the system. However, the first law of thermodynamics (4.11) suggests that it is most natural to view energy as a function of entropy and volume:  $E = E(S, V)$ . This has the advantage that the partial derivatives are familiar quantities,

$$\left. \frac{\partial E}{\partial S} \right|_V = T \quad , \quad \left. \frac{\partial E}{\partial V} \right|_S = -p$$

We saw both of these results in Section 1. It is also interesting to look at the double mixed partial derivative,  $\partial^2 E/\partial S\partial V = \partial^2 E/\partial V\partial S$ . This gives the relation

$$\left. \frac{\partial T}{\partial V} \right|_S = - \left. \frac{\partial p}{\partial S} \right|_V \quad (4.23)$$

This result is mathematically trivial. Yet physically it is far from obvious. It is the first of four such identities, known as the *Maxwell Relations*.



The other Maxwell relations are derived by playing the same game with  $F$ ,  $G$  and  $H$ . From the properties (4.19), we see that taking mixed partial derivatives of the free energy gives us,

$$\left. \frac{\partial S}{\partial V} \right|_T = \left. \frac{\partial p}{\partial T} \right|_V \quad (4.24)$$

The Gibbs free energy gives us

$$\left. \frac{\partial S}{\partial p} \right|_T = - \left. \frac{\partial V}{\partial T} \right|_p \quad (4.25)$$

While the enthalpy gives

$$\left. \frac{\partial T}{\partial p} \right|_S = \left. \frac{\partial V}{\partial S} \right|_p \quad (4.26)$$

The four Maxwell relations (4.23), (4.24), (4.25) and (4.26) are remarkable in that they are mathematical identities that hold for any system. They are particularly useful because they relate quantities which are directly measurable with those which are less easy to determine experimentally, such as entropy.

It is not too difficult to remember the Maxwell relations. Cross-multiplication always yields terms in pairs:  $TS$  and  $pV$ , which follows essentially on dimensional grounds. The four relations are simply the four ways to construct such equations. The only tricky part is to figure out the minus signs.

## Heat Capacities Revisited

By taking further derivatives of the Maxwell relations, we can derive yet more equations which involve more immediate quantities. You will be asked to prove a number of these on the examples sheet, including results for the heat capacity at constant volume,  $C_V = T \partial S / \partial T|_V$ , as well as the heat capacity at constant pressure  $C_p = T \partial S / \partial T|_p$ . Useful results include,

$$\left. \frac{\partial C_V}{\partial V} \right|_T = T \left. \frac{\partial^2 p}{\partial T^2} \right|_V, \quad \left. \frac{\partial C_p}{\partial p} \right|_T = -T \left. \frac{\partial^2 V}{\partial T^2} \right|_p$$

You will also prove a relationship between these two heat capacities,

$$C_p - C_V = T \left. \frac{\partial V}{\partial T} \right|_p \left. \frac{\partial p}{\partial T} \right|_V$$

This last expression has a simple consequence. Consider, for example, an ideal gas obeying  $pV = Nk_B T$ . Evaluating the right-hand side gives us

$$C_p - C_v = Nk_B$$

There is an intuitive reason why  $C_p$  is greater than  $C_V$ . At constant volume, if you dump heat into a system then it all goes into increasing the temperature. However, at constant pressure some of this energy will cause the system to expand, thereby doing work. This leaves less energy to raise the temperature, ensuring that  $C_p > C_V$ .

#### 4.5 The Third Law

The second law only talks about entropy differences. We can see this in (4.10) where the entropy is defined with respect to some reference state. The third law, sometimes called *Nernst's postulate*, provides an absolute scale for the entropy. It is usually taken to be

$$\lim_{T \rightarrow 0} S(T) = 0$$

In fact we can relax this slightly to allow a finite entropy, but vanishing entropy density  $S/N$ . We know from the Boltzmann definition that, at  $T = 0$ , the entropy is simply the logarithm of the degeneracy of the ground state of the system. The third law really requires  $S/N \rightarrow 0$  as  $T \rightarrow 0$  and  $N \rightarrow \infty$ . This then says that the ground state entropy shouldn't grow extensively with  $N$ .

The third law doesn't quite have the same teeth as its predecessors. Each of the first three laws provided us with a new function of state of the system: the zeroth law gave us temperature; the first law energy; and the second law entropy. There is no such reward from the third law.

One immediate consequence of the third law is that heat capacities must also tend to zero as  $T \rightarrow 0$ . This follows from the equation (1.10)

$$S(B) - S(A) = \int_A^B dT \frac{C_V}{T}$$

If the entropy at zero temperature is finite then the integral must converge which tells us that  $C_V \rightarrow T^n$  for some  $n \geq 1$  or faster. Looking back at the various examples of heat capacities, we can check that this is always true. (The case of a degenerate Fermi gas is right on the borderline with  $n = 1$ ). However, in each case the fact that the heat capacity vanishes is due to quantum effects freezing out degrees of freedom.

In contrast, when we restrict to the classical physics, we typically find constant heat capacities such as the classical ideal gas (2.10) or the Dulong-Petit law (3.15). These would both violate the third law. In that sense, the third law is an admission that the low temperature world is not classical. It is quantum.

Thinking about things quantum mechanically, it is very easy to see why the third law holds. A system that violates the third law would have a very large – indeed, an extensive – number of ground states. But large degeneracies do not occur naturally in quantum mechanics. Moreover, even if you tune the parameters of a Hamiltonian so that there are a large number of ground states, then any small perturbation will lift the degeneracy, introducing an energy splitting between the states. From this perspective, the third law is a simple a consequence of the properties of the eigenvalue problem for large matrices.

## 5. Phase Transitions

A *phase transition* is an abrupt, discontinuous change in the properties of a system. We've already seen one example of a phase transition in our discussion of Bose-Einstein condensation. In that case, we had to look fairly closely to see the discontinuity: it was lurking in the derivative of the heat capacity. In other phase transitions — many of them already familiar — the discontinuity is more manifest. Examples include steam condensing to water and water freezing to ice.

In this section we'll explore a couple of phase transitions in some detail and extract some lessons that are common to all transitions.

### 5.1 Liquid-Gas Transition

Recall that we derived the van der Waals equation of state for a gas (2.31) in Section 2.5. We can write the van der Waals equation as

$$p = \frac{k_B T}{v - b} - \frac{a}{v^2} \quad (5.1)$$

where  $v = V/N$  is the volume per particle. In the literature, you will also see this equation written in terms of the particle density  $\rho = 1/v$ .

On the right we fix  $T$  at different values and sketch the graph of  $p$  vs.  $V$  determined by the van der Waals equation. These curves are *isotherms* — line of constant temperature. As we can see from the diagram, the isotherms take three different shapes depending on the value of  $T$ . The top curve shows the isotherm for large values of  $T$ . Here we can effectively ignore the  $-a/v^2$  term. (Recall that  $v$  cannot take values smaller than  $b$ , reflecting the fact that atoms cannot approach to arbitrarily closely). The result is a monotonically decreasing function, essentially the same as we would get for an ideal gas. In contrast, when  $T$  is low enough, the second term in (5.1) can compete with the first term. Roughly speaking, this happens when  $k_B T \sim a/v$  is in the allowed region  $v > b$ . For these low value of the temperature, the isotherm has a wiggle.

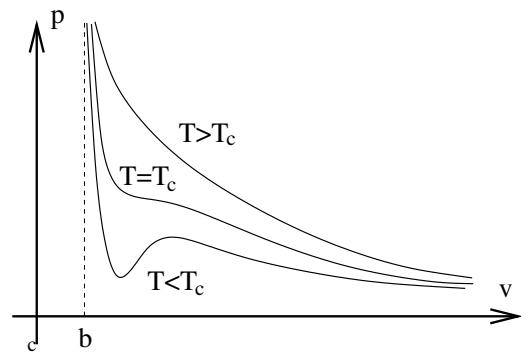

Figure 35:

At some intermediate temperature, the wiggle must flatten out so that the bottom curve looks like the top one. This happens when the maximum and minimum meet to form an inflection point. Mathematically, we are looking for a solution to  $dp/dv = d^2p/dv^2 = 0$ . It is simple to check that these two equations only have a solution at the *critical temperature*  $T = T_c$  given by

$$k_B T_c = \frac{8a}{27b} \quad (5.2)$$

Let's look in more detail at the  $T < T_c$  curve. For a range of pressures, the system can have three different choices of volume. A typical, albeit somewhat exaggerated, example of this curve is shown in the figure below. What's going on? How should we interpret the fact that the system can seemingly live at three different densities  $\rho = 1/v$ ?

First look at the middle solution. This has some fairly weird properties. We can see from the graph that the gradient is positive:  $dp/dv|_T > 0$ . This means that if we apply a force to the container to squeeze the gas, the pressure decreases. The gas doesn't push back; it just relents. But if we expand the gas, the pressure increases and the gas pushes harder. Both of these properties are telling us that the gas in that state is unstable.

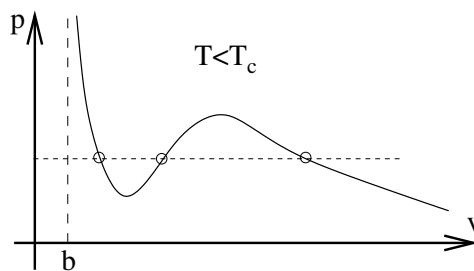

**Figure 36:**

If we were able to create such a state, it wouldn't hang around for long because any tiny perturbation would lead to a rapid, explosive change in its density. If we want to find states which we are likely to observe in Nature then we should look at the other two solutions.

The solution to the left on the graph has  $v$  slightly bigger than  $b$ . But, recall from our discussion of Section 2.5 that  $b$  is the closest that the atoms can get. If we have  $v \sim b$ , then the atoms are very densely packed. Moreover, we can also see from the graph that  $|dp/dv|$  is very large for this solution which means that the state is very difficult to compress: we need to add a great deal of pressure to change the volume only slightly. We have a name for this state: it is a *liquid*.

You may recall that our original derivation of the van der Waals equation was valid only for densities much lower than the liquid state. This means that we don't really trust (5.1) on this solution. Nonetheless, it is interesting that the equation predicts the existence of liquids and our plan is to gratefully accept this gift and push ahead to explore what the van der Waals tells us about the liquid-gas transition. We will see that it captures many of the qualitative features of the phase transition.

The last of the three solutions is the one on the right in the figure. This solution has  $v \gg b$  and small  $|dp/dv|$ . It is the *gas state*. Our goal is to understand what happens in between the liquid and gas state. We know that the naive, middle, solution given to us by the van der Waals equation is unstable. What replaces it?

### 5.1.1 Phase Equilibrium

Throughout our derivation of the van der Waals equation in Section 2.5, we assumed that the system was at a fixed density. But the presence of two solutions — the liquid and gas state — allows us to consider more general configurations: part of the system could be a liquid and part could be a gas.

How do we figure out if this indeed happens? Just because both liquid and gas states can exist, doesn't mean that they can cohabit. It might be that one is preferred over the other. We already saw some conditions that must be satisfied in order for two systems to sit in equilibrium back in Section 1. Mechanical and thermal equilibrium are guaranteed if two systems have the same pressure and temperature respectively. But both of these are already guaranteed by construction for our two liquid and gas solutions: the two solutions sit on the same isotherm and at the same value of  $p$ . We're left with only one further requirement that we must satisfy which arises because the two systems can exchange particles. This is the requirement of chemical equilibrium,

$$\mu_{\text{liquid}} = \mu_{\text{gas}} \tag{5.3}$$

Because of the relationship (4.22) between the chemical potential and the Gibbs free energy, this is often expressed as

$$g_{\text{liquid}} = g_{\text{gas}} \tag{5.4}$$

where  $g = G/N$  is the Gibbs free energy per particle.

Notice that all the equilibrium conditions involve only intensive quantities:  $p$ ,  $T$  and  $\mu$ . This means that if we have a situation where liquid and gas are in equilibrium, then we can have any number  $N_{\text{liquid}}$  of atoms in the liquid state and any number  $N_{\text{gas}}$  in the gas state. But how can we make sure that chemical equilibrium (5.3) is satisfied?

### Maxwell Construction

We want to solve  $\mu_{\text{liquid}} = \mu_{\text{gas}}$ . We will think of the chemical potential as a function of  $p$  and  $T$ :  $\mu = \mu(p, T)$ . Importantly, we won't assume that  $\mu(p, T)$  is single valued since that would be assuming the result we're trying to prove! Instead we will show that if we fix  $T$ , the condition (5.3) can only be solved for a very particular value of pressure

$p$ . To see this, start in the liquid state at some fixed value of  $p$  and  $T$  and travel along the isotherm. The infinitesimal change in the chemical potential is

$$d\mu = \left. \frac{\partial\mu}{\partial p} \right|_T dp$$

However, we can get an expression for  $\partial\mu/\partial p$  by recalling that arguments involving extensive and intensive variables tell us that the chemical potential is proportional to the Gibbs free energy:  $G(p, T, N) = \mu(p, T)N$  (4.22). Looking back at the variation of the Gibbs free energy (4.21) then tells us that

$$\left. \frac{\partial G}{\partial p} \right|_{N,T} = \left. \frac{\partial\mu}{\partial p} \right|_T N = V \quad (5.5)$$

Integrating along the isotherm then tells us the chemical potential of any point on the curve,

$$\mu(p, T) = \mu_{\text{liquid}} + \int_{p_{\text{liquid}}}^p dp' \frac{V(p', T)}{N}$$

When we get to gas state at the same pressure  $p = p_{\text{liquid}}$  that we started from, the condition for equilibrium is  $\mu = \mu_{\text{liquid}}$ . Which means that the integral has to vanish. Graphically this is very simple to describe: the two shaded areas in the graph must have equal area. This condition, known as the *Maxwell construction*, tells us the pressure at which gas and liquid can co-exist.

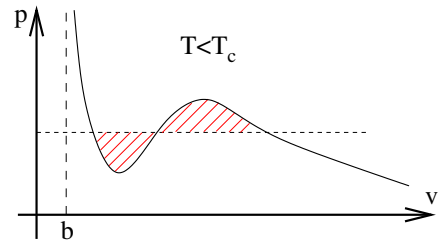

**Figure 37:**

I should confess that there's something slightly dodgy about the Maxwell construction. We already argued that the part of the isotherm with  $dp/dv > 0$  suffers an instability and is unphysical. But we needed to trek along that part of the curve to derive our result. There are more rigorous arguments that give the same answer.

For each isotherm, we can determine the pressure at which the liquid and gas states are in equilibrium. This gives us the *co-existence curve*, shown by the dotted line in Figure 38. Inside this region, liquid and gas can both exist at the same temperature and pressure. But there is nothing that tells us how much gas there should be and how much liquid: atoms can happily move from the liquid state to the gas state. This means that while the density of gas and liquid is fixed, the *average* density of the system is not. It can vary between the gas density and the liquid density simply by changing the amount of liquid. The upshot of this argument is that inside the co-existence curves, the isotherms simply become flat lines, reflecting the fact that the density can take any value. This is shown in graph on the right of Figure 38.

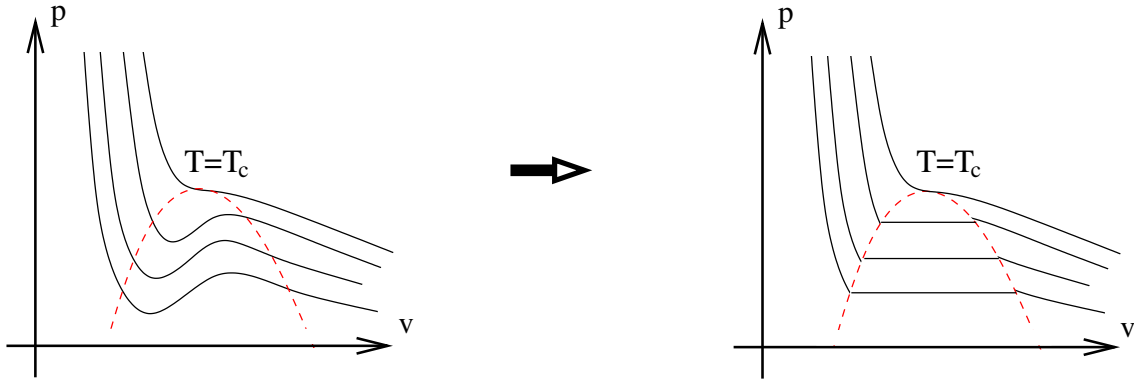

**Figure 38:** The co-existence curve in red, resulting in constant pressure regions consisting of a harmonious mixture of vapour and liquid.

To illustrate the physics of this situation, suppose that we sit at some fixed density  $\rho = 1/v$  and cool the system down from a high temperature to  $T < T_c$  at a point inside the co-existence curve so that we're now sitting on one of the flat lines. Here, the system is neither entirely liquid, nor entirely gas. Instead it will split into gas, with density  $1/v_{\text{gas}}$ , and liquid, with density  $1/v_{\text{liquid}}$  so that the average density remains  $1/v$ . The system undergoes *phase separation*. The minimum energy configuration will typically be a single phase of liquid and one of gas because the interface between the two costs energy. (We will derive an expression for this energy in Section 5.5). The end result is shown on the right. In the presence of gravity, the higher density liquid will indeed sink to the bottom.

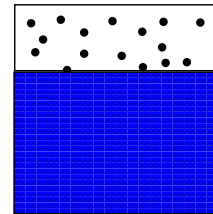

**Figure 39:**

### Meta-Stable States

We've understood what replaces the unstable region of the van der Waals phase diagram. But we seem to have removed more states than anticipated: parts of the Van der Waals isotherm that had  $dp/dv < 0$  are contained in the co-existence region and replaced by the flat pressure lines. This is the region of the  $p$ - $V$  phase diagram that is contained between the two dotted lines in the figure to the right. The outer dotted line is the co-existence curve. The inner dotted curve is constructed to pass through the stationary points of the van der Waals isotherms. It is called the *spinodal curve*.

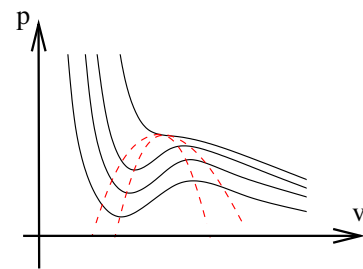

**Figure 40:**



The van der Waals states which lie between the spinodal curve and the co-existence curve are good states. But they are meta-stable. One can show that their Gibbs free energy is higher than that of the liquid-gas equilibrium at the same  $p$  and  $T$ . However, if we compress the gas very slowly we can coax the system into this state. It is known as a supercooled vapour. It is delicate. Any small disturbance will cause some amount of the gas to condense into the liquid. Similarly, expanding a liquid beyond the co-existence curve results in an meta-stable, superheated liquid.

### 5.1.2 The Clausius-Clapeyron Equation

We can also choose to plot the liquid-gas phase diagram on the  $p - T$  plane. Here the co-existence region is squeezed into a line: if we're sitting in the gas phase and increase the pressure just a little bit at fixed  $T < T_c$  then we jump immediately to the liquid phase. This appears as a discontinuity in the volume. Such discontinuities are the sign of a phase transition. The end result is sketched in the figure to the right; the thick solid line denotes the presence of a phase transition.

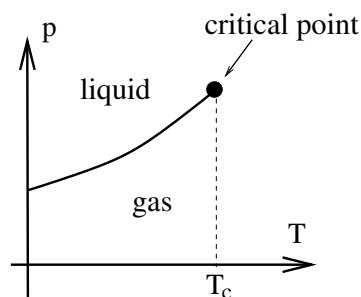

**Figure 41:**

Either side of the line, all particles are either in the gas or liquid phase. We know from (5.4) that the Gibbs free energies of these two states are equal,

$$G_{\text{liquid}} = G_{\text{gas}}$$

So  $G$  is continuous as we move across the line of phase transitions. Suppose that we sit on the line itself and move up it. How does  $G$  change? We can easily compute this from (4.21),

$$\begin{aligned} dG_{\text{liquid}} &= -S_{\text{liquid}}dT + V_{\text{liquid}}dp \\ &= dG_{\text{gas}} = -S_{\text{gas}}dT + V_{\text{gas}}dp \end{aligned}$$

But this gives us a nice expression for the slope of the line of phase transitions in the  $p$ - $T$  plane. It is

$$\frac{dp}{dT} = \frac{S_{\text{gas}} - S_{\text{liquid}}}{V_{\text{gas}} - V_{\text{liquid}}}$$

We usually define the *latent heat*

$$L = T(S_{\text{gas}} - S_{\text{liquid}})$$

This is the energy released as we pass through the phase transition. We see that the slope of the line in the  $p$ - $T$  plane is determined by the ratio of latent heat released in the phase transition and the discontinuity in volume. The result is known as the *Clausius-Clapeyron equation*,

$$\frac{dp}{dT} = \frac{L}{T(V_{\text{gas}} - V_{\text{liquid}})} \quad (5.6)$$

There is a classification of phase transitions, due originally to Ehrenfest. When the  $n^{\text{th}}$  derivative of a thermodynamic potential (either  $F$  or  $G$  usually) is discontinuous, we say we have an  $n^{\text{th}}$  order phase transition. In practice, we nearly always deal with first, second and (very rarely) third order transitions. The liquid-gas transition releases latent heat, which means that  $S = -\partial F/\partial T$  is discontinuous. Alternatively, we can say that  $V = \partial G/\partial p$  is discontinuous. Either way, it is a *first order phase transition*. The Clausius-Clapeyron equation (5.6) applies to any first order transition.

As we approach  $T \rightarrow T_c$ , the discontinuity diminishes and  $S_{\text{liquid}} \rightarrow S_{\text{gas}}$ . At the critical point  $T = T_c$  we have a second order phase transition. Above the critical point, there is no sharp distinction between the gas phase and liquid phase.

For most simple materials, the phase diagram above is part of a larger phase diagram which includes solids at smaller temperatures or higher pressures. A generic version of such a phase diagram is shown to the right. The van der Waals equation is missing the physics of solidification and includes only the liquid-gas line.

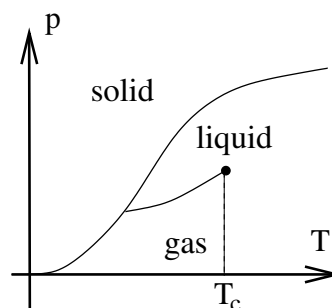

Figure 42:

### An Approximate Solution to the Clausius-Clapeyron Equation

We can solve the Clausius-Clapeyron solution if we make the following assumptions:

- The latent heat  $L$  is constant.
- $V_{\text{gas}} \gg V_{\text{liquid}}$ , so  $V_{\text{gas}} - V_{\text{liquid}} \approx V_{\text{gas}}$ . For water, this is an error of less than 0.1%
- Although we derived the phase transition using the van der Waals equation, now we've got equation (5.6) we'll pretend the gas obeys the ideal gas law  $pV = Nk_B T$ .

With these assumptions, it is simple to solve (5.6). It reduces to

$$\frac{dP}{dT} = \frac{Lp}{Nk_B T} \quad \Rightarrow \quad p = p_0 e^{-L/k_B T}$$

### 5.1.3 The Critical Point

Let's now return to discuss some aspects of life at the critical point. We previously worked out the critical temperature (5.2) by looking for solutions to simultaneous equations  $\partial p/\partial v = \partial^2 p/\partial v^2 = 0$ . There's a slightly more elegant way to find the critical point which also quickly gives us  $p_c$  and  $v_c$  as well. We rearrange the van der Waals equation (5.1) to get a cubic,

$$pv^3 - (pb + k_B T)v^2 + av - ab = 0$$

For  $T < T_c$ , this equation has three real roots. For  $T > T_c$  there is just one. Precisely at  $T = T_c$ , the three roots must therefore coincide (before two move off onto the complex plane). At the critical point, this curve can be written as

$$p_c(v - v_c)^3 = 0$$

Comparing the coefficients tells us the values at the critical point,

$$k_B T_c = \frac{8a}{27b} \quad , \quad v_c = 3b \quad , \quad p_c = \frac{a}{27b^2} \quad (5.7)$$

### The Law of Corresponding States

We can invert the relations (5.7) to express the parameters  $a$  and  $b$  in terms of the critical values, which we then substitute back into the van der Waals equation. To this end, we define the *reduced* variables,

$$\bar{T} = \frac{T}{T_c} \quad , \quad \bar{v} = \frac{v}{v_c} \quad \bar{p} = \frac{p}{p_c}$$

The advantage of working with  $\bar{T}$ ,  $\bar{v}$  and  $\bar{p}$  is that it allows us to write the van der Waals equation (5.1) in a form that is universal to all gases, usually referred to as the law of corresponding states

$$\bar{p} = \frac{8}{3} \frac{\bar{T}}{\bar{v} - 1/3} - \frac{3}{\bar{v}^2}$$

Moreover, because the three variables  $T_c$ ,  $p_c$  and  $v_c$  at the critical point are expressed in terms of just two variables,  $a$  and  $b$  (5.7), we can construct a combination of them which is independent of  $a$  and  $b$  and therefore supposedly the same for all gases. This is the universal compressibility ratio,

$$\frac{p_c v_c}{k_B T_c} = \frac{3}{8} = 0.375 \quad (5.8)$$

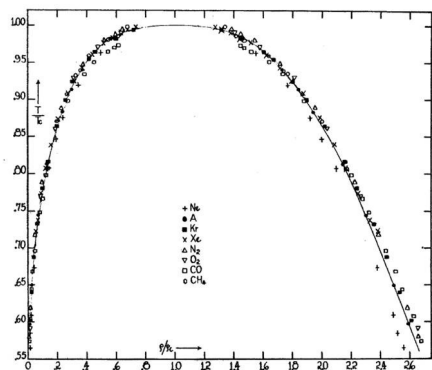

**Figure 43:** The co-existence curve for gases. Data is plotted for  $Ne$ ,  $Ar$ ,  $Kr$ ,  $Xe$ ,  $N_2$ ,  $O_2$ ,  $CO$  and  $CH_4$ .

Comparing to real gases, this number is a little high. Values range from around 0.28 to 0.3. We shouldn't be too discouraged by this; after all, we knew from the beginning that the van der Waals equation is unlikely to be accurate in the liquid regime. Moreover, the fact that gases have a critical point (defined by three variables  $T_c$ ,  $p_c$  and  $v_c$ ) guarantees that a similar relationship would hold for any equation of state which includes just two parameters (such as  $a$  and  $b$ ) but would most likely fail to hold for equations of state that included more than two parameters.

Dubious as its theoretical foundation is, the law of corresponding states is the first suggestion that something remarkable happens if we describe a gas in terms of its reduced variables. More importantly, there is striking experimental evidence to back this up! Figure 43 shows the Guggenheim plot, constructed in 1945. The co-existence curve for 8 different gases is plotted in reduced variables:  $\bar{T}$  along the vertical axis;  $\bar{\rho} = 1/\bar{v}$  along the horizontal. The gases vary in complexity from the simple monatomic gas  $Ne$  to the molecule  $CH_4$ . As you can see, the co-existence curve for all gases is essentially the same, with the chemical make-up largely forgotten. There is clearly something interesting going on. How to understand it?

### Critical Exponents

We will focus attention on physics close to the critical point. It is not immediately obvious what are the right questions to ask. It turns out that the questions which have the most interesting answer are concerned with how various quantities change as we approach the critical point. There are lots of ways to ask questions of this type since there are many quantities of interest and, for each of them, we could approach

the critical point from different directions. Here we'll look at the behaviour of three quantities to get a feel for what happens.

First, we can ask what happens to the difference in (inverse) densities  $v_{\text{gas}} - v_{\text{liquid}}$  as we approach the critical point along the co-existence curve. For  $T < T_c$ , or equivalently  $\bar{T} < 1$ , the reduced van der Waals equation (5.8) has two stable solutions,

$$\bar{p} = \frac{8\bar{T}}{3\bar{v}_{\text{liquid}} - 1} - \frac{3}{\bar{v}_{\text{liquid}}^2} = \frac{8\bar{T}}{3\bar{v}_{\text{gas}} - 1} - \frac{3}{\bar{v}_{\text{gas}}^2}$$

If we solve this for  $\bar{T}$ , we have

$$\bar{T} = \frac{(3\bar{v}_{\text{liquid}} - 1)(3\bar{v}_{\text{gas}} - 1)(\bar{v}_{\text{liquid}} + \bar{v}_{\text{gas}})}{8\bar{v}_{\text{gas}}^2 \bar{v}_{\text{liquid}}^2}$$

Notice that as we approach the critical point,  $\bar{v}_{\text{gas}}, \bar{v}_{\text{liquid}} \rightarrow 1$  and the equation above tells us that  $\bar{T} \rightarrow 1$  as expected. We can see exactly how we approach  $\bar{T} = 1$  by expanding the right hand side for small  $\epsilon \equiv \bar{v}_{\text{gas}} - \bar{v}_{\text{liquid}}$ . To do this quickly, it's best to notice that the equation is symmetric in  $\bar{v}_{\text{gas}}$  and  $\bar{v}_{\text{liquid}}$ , so close to the critical point we can write  $\bar{v}_{\text{gas}} = 1 + \epsilon/2$  and  $\bar{v}_{\text{liquid}} = 1 - \epsilon/2$ . Substituting this into the equation above and keeping just the leading order term, we find

$$\bar{T} \approx 1 - \frac{1}{16}(\bar{v}_{\text{gas}} - \bar{v}_{\text{liquid}})^2$$

Or, re-arranging, as we approach  $T_c$  along the co-existence curve,

$$v_{\text{gas}} - v_{\text{liquid}} \sim (T_c - T)^{1/2} \tag{5.9}$$

This is the answer to our first question.

Our second variant of the question is: how does the volume change with pressure as we move along the critical isotherm. It turns out that we can answer this question without doing any work. Notice that at  $T = T_c$ , there is a unique pressure for a given volume  $p(v, T_c)$ . But we know that  $\partial p / \partial v = \partial^2 p / \partial v^2 = 0$  at the critical point. So a Taylor expansion around the critical point must start with the cubic term,

$$p - p_c \sim (v - v_c)^3 \tag{5.10}$$

This is the answer to our second question.

Our third and final variant of the question concerns the compressibility, defined as

$$\kappa = -\frac{1}{v} \left. \frac{\partial v}{\partial p} \right|_T \quad (5.11)$$

We want to understand how  $\kappa$  changes as we approach  $T \rightarrow T_c$  from above. In fact, we met the compressibility before: it was the feature that first made us nervous about the van der Waals equation since  $\kappa$  is negative in the unstable region. We already know that at the critical point  $\partial p / \partial v|_{T_c} = 0$ . So expanding for temperatures close to  $T_c$ , we expect

$$\left. \frac{\partial p}{\partial v} \right|_{T;v=v_c} = -a(T - T_c) + \dots$$

This tells us that the compressibility should diverge at the critical point, scaling as

$$\kappa \sim (T - T_c)^{-1} \quad (5.12)$$

We now have three answers to three questions: (5.9), (5.10) and (5.12). Are they right?! By which I mean: do they agree with experiment? Remember that we're not sure that we can trust the van der Waals equation at the critical point so we should be nervous. However, there is also reason for some confidence. Notice, in particular, that in order to compute (5.10) and (5.12), we didn't actually need any details of the van der Waals equation. We simply needed to assume the existence of the critical point and an analytic Taylor expansion of various quantities in the neighbourhood. Given that the answers follow from such general grounds, one may hope that they provide the correct answers for a gas in the neighbourhood of the critical point even though we know that the approximations that went into the van der Waals equation aren't valid there. Fortunately, that isn't the case: physics is much more interesting than that!

The experimental results for a gas in the neighbourhood of the critical point do share one feature in common with the discussion above: they are completely independent of the atomic make-up of the gas. However, the scaling that we computed using the van der Waals equation is not fully accurate. The correct results are as follows. As we approach the critical point along the co-existence curve, the densities scale as

$$v_{\text{gas}} - v_{\text{liquid}} \sim (T_c - T)^\beta \quad \text{with} \quad \beta \approx 0.32$$

(Note that the exponent  $\beta$  has nothing to do with inverse temperature. We're just near the end of the course and running out of letters and  $\beta$  is the canonical name for this exponent). As we approach along an isotherm,

$$p - p_c \sim (v - v_c)^\delta \quad \text{with} \quad \delta \approx 4.8$$

Finally, as we approach  $T_c$  from above, the compressibility scales as

$$\kappa \sim (T - T_c)^{-\gamma} \quad \text{with} \quad \gamma \approx 1.2$$

The quantities  $\beta$ ,  $\gamma$  and  $\delta$  are examples of *critical exponents*. We will see more of them shortly. The van der Waals equation provides only a crude first approximation to the critical exponents.

## Fluctuations

We see that the van der Waals equation didn't do too badly in capturing the dynamics of an interacting gas. It gets the qualitative behaviour right, but fails on precise quantitative tests. So what went wrong? We mentioned during the derivation of the van der Waals equation that we made certain approximations that are valid only at low density. So perhaps it is not surprising that it fails to get the numbers right near the critical point  $v = 3b$ . But there's actually a deeper reason that the van der Waals equation fails: fluctuations.

This is simplest to see in the grand canonical ensemble. Recall that back in Section 1 that we argued that  $\Delta N/N \sim 1/\sqrt{N}$ , which allowed us to happily work in the grand canonical ensemble even when we actually had fixed particle number. In the context of the liquid-gas transition, fluctuating particle number is the same thing as fluctuating density  $\rho = N/V$ . Let's revisit the calculation of  $\Delta N$  near the critical point. Using (1.45) and (1.48), the grand canonical partition function can be written as  $\log \mathcal{Z} = -\beta V p(T, \mu)$ , so the average particle number (1.42) is

$$\langle N \rangle = V \left. \frac{\partial p}{\partial \mu} \right|_{T,V}$$

We already have an expression for the variance in the particle number in (1.43),

$$\Delta N^2 = \frac{1}{\beta} \left. \frac{\partial \langle N \rangle}{\partial \mu} \right|_{T,V}$$

Dividing these two expressions, we have

$$\frac{\Delta N^2}{N} = \frac{1}{V\beta} \left. \frac{\partial \langle N \rangle}{\partial \mu} \right|_{T,V} \left. \frac{\partial \mu}{\partial p} \right|_{T,V} = \frac{1}{V\beta} \left. \frac{\partial \langle N \rangle}{\partial p} \right|_{T,V}$$

But we can re-write this expression using the general relationship between partial derivatives  $\partial x/\partial y|_z \partial y/\partial z|_x \partial z/\partial x|_y = -1$ . We then have

$$\frac{\Delta N^2}{N} = -\frac{1}{\beta} \left. \frac{\partial \langle N \rangle}{\partial V} \right|_{p,T} \frac{1}{V} \left. \frac{\partial V}{\partial p} \right|_{N,T}$$

This final expression relates the fluctuations in the particle number to the compressibility (5.11). But the compressibility is diverging at the critical point and this means that there are large fluctuations in the density of the fluid at this point. The result is that any simple equation of state, like the van der Waals equation, which works only with the average volume, pressure and density will miss this key aspect of the physics.

Understanding how to correctly account for these fluctuations is the subject of *critical phenomena*. It has close links with the *renormalization group* and *conformal field theory* which also arise in particle physics and string theory. You will meet some of these ideas in next year’s *Statistical Field Theory* course. Here we will turn to a different phase transition which will allow us to highlight some of the key ideas.

## 5.2 The Ising Model

The Ising model is one of the touchstones of modern physics; a simple system that exhibits non-trivial and interesting behaviour.

The Ising model consists of  $N$  sites in a  $d$ -dimensional lattice. On each lattice site lives a quantum spin that can sit in one of two states: spin up or spin down. We’ll call the eigenvalue of the spin on the  $i^{\text{th}}$  lattice site  $s_i$ . If the spin is up,  $s_i = +1$ ; if the spin is down,  $s_i = -1$ .

The spins sit in a magnetic field that endows an energy advantage to those which point up,

$$E_B = -B \sum_{i=1}^N s_i$$

(A comment on notation:  $B$  should be properly denoted  $H$ . We’re sticking with  $B$  to avoid confusion with the Hamiltonian. There is also a factor of the magnetic moment which has been absorbed into the definition of  $B$ ). The lattice system with energy  $E_B$  is equivalent to the two-state system that we first met when learning the techniques of statistical mechanics back in Section 1.2.3. However, the Ising model contains an additional complication that makes the system much more interesting: this is an interaction between neighbouring spins. The full energy of the system is therefore,

$$E = -J \sum_{\langle ij \rangle} s_i s_j - B \sum_i s_i \quad (5.13)$$

The notation  $\langle ij \rangle$  means that we sum over all “nearest neighbour” pairs in the lattice. The number of such pairs depends both on the dimension  $d$  and the type of lattice.



We'll denote the number of nearest neighbours as  $q$ . For example, in  $d = 1$  a lattice has  $q = 2$ ; in  $d = 2$ , a square lattice has  $q = 4$ . A square lattice in  $d$  dimensions has  $q = 2d$ .

If  $J > 0$ , neighbouring spins prefer to be aligned ( $\uparrow\uparrow$  or  $\downarrow\downarrow$ ). In the context of magnetism, such a system is called a *ferromagnet*. If  $J < 0$ , the spins want to anti-align ( $\uparrow\downarrow$ ). This is an *anti-ferromagnet*. In the following, we'll choose  $J > 0$  although for the level of discussion needed for this course, the differences are minor.

We work in the canonical ensemble and introduce the partition function

$$Z = \sum_{\{s_i\}} e^{-\beta E[s_i]} \quad (5.14)$$

While the effect of both  $J > 0$  and  $B \neq 0$  is to make it energetically preferable for the spins to align, the effect of temperature will be to randomize the spins, with entropy winning out over energy. Our interest is in the average spin, or average *magnetization*

$$m = \frac{1}{N} \sum_i \langle s_i \rangle = \frac{1}{N\beta} \frac{\partial \log Z}{\partial B} \quad (5.15)$$

### The Ising Model as a Lattice Gas

Before we develop techniques to compute the partition function (5.14), it's worth pointing out that we can drape slightly different words around the mathematics of the Ising model. It need not be interpreted as a system of spins; it can also be thought of as a lattice description of a gas.

To see this, consider the same  $d$ -dimensional lattice as before, but now with particles hopping between lattice sites. These particles have hard cores, so no more than one can sit on a single lattice site. We introduce the variable  $n_i \in \{0, 1\}$  to specify whether a given lattice site, labelled by  $i$ , is empty ( $n_i = 0$ ) or filled ( $n_i = 1$ ). We can also introduce an attractive force between atoms by offering them an energetic reward if they sit on neighbouring sites. The Hamiltonian of such a lattice gas is given by

$$E = -4J \sum_{\langle ij \rangle} n_i n_j - \mu \sum_i n_i$$

where  $\mu$  is the chemical potential which determines the overall particle number. But this Hamiltonian is trivially the same as the Ising model (5.13) if we make the identification

$$s_i = 2n_i - 1 \in \{-1, 1\}$$

The chemical potential  $\mu$  in the lattice gas plays the role of magnetic field in the spin system while the magnetization of the system (5.15) measures the average density of particles away from half-filling.

### 5.2.1 Mean Field Theory

For general lattices, in arbitrary dimension  $d$ , the sum (5.14) cannot be performed. An exact solution exists in  $d = 1$  and, when  $B = 0$ , in  $d = 2$ . (The  $d = 2$  solution is originally due to Onsager and is famously complicated! Simpler solutions using more modern techniques have since been discovered).

Here we'll develop an approximate method to evaluate  $Z$  known as *mean field theory*. We write the interactions between neighbouring spins in term of their deviation from the average spin  $m$ ,

$$\begin{aligned} s_i s_j &= [(s_i - m) + m][(s_j - m) + m] \\ &= (s_i - m)(s_j - m) + m(s_j - m) + m(s_i - m) + m^2 \end{aligned}$$

The mean field approximation means that we assume that the fluctuations of spins away from the average are small which allows us to neglect the first term above. Notice that this isn't the statement that the variance of an individual spin is small; that can never be true because  $s_i$  takes values  $+1$  or  $-1$  so  $\langle s_i^2 \rangle = 1$  and the variance  $\langle (s_i - m)^2 \rangle$  is always large. Instead, the mean field approximation is a statement about fluctuations between spins on neighbouring sites, so the first term above can be neglected when summing over  $\sum_{\langle ij \rangle}$ . We can then write the energy (5.13) as

$$\begin{aligned} E_{\text{mf}} &= -J \sum_{\langle ij \rangle} [m(s_i + s_j) - m^2] - B \sum_i s_i \\ &= \frac{1}{2} J N q m^2 - (J q m + B) \sum_i s_i \end{aligned} \quad (5.16)$$

where the factor of  $Nq/2$  in the first term is simply the number of nearest neighbour pairs  $\sum_{\langle ij \rangle}$ . The factor of  $1/2$  is there because  $\sum_{\langle ij \rangle}$  is a sum over pairs rather than a sum of individual sites. (If you're worried about this formula, you should check it for a simple square lattice in  $d = 1$  and  $d = 2$  dimensions). A similar factor in the second term cancelled the factor of 2 due to  $(s_i + s_j)$ .

We see that the mean field approximation has removed the interactions. The Ising model reduces to the two state system that we saw way back in Section 1. The result of the interactions is that a given spin feels the average effect of its neighbour's spins through a contribution to the effective magnetic field,

$$B_{\text{eff}} = B + J q m$$

Once we've taken into account this extra contribution to  $B_{\text{eff}}$ , each spin acts indepen-

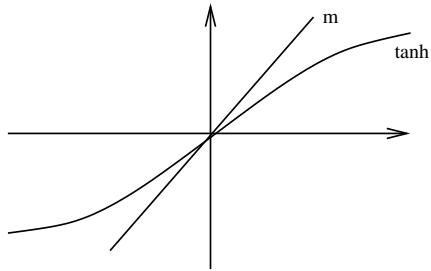

**Figure 44:**  $\tanh(Jqm\beta)$  for  $Jq\beta < 1$

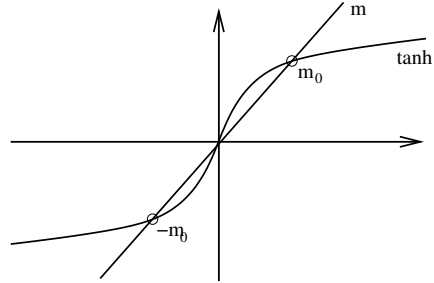

**Figure 45:**  $\tanh(Jqm\beta)$  for  $Jq\beta > 1$

dently and it is easy to write the partition function. It is

$$\begin{aligned} Z &= e^{-\frac{1}{2}\beta J N q m^2} (e^{-\beta B_{\text{eff}}} + e^{\beta B_{\text{eff}}})^N \\ &= e^{-\frac{1}{2}\beta J N q m^2} 2^N \cosh^N \beta B_{\text{eff}} \end{aligned} \quad (5.17)$$

However, we're not quite done. Our result for the partition function  $Z$  depends on  $B_{\text{eff}}$  which depends on  $m$  which we don't yet know. However, we can use our expression for  $Z$  to self-consistently determine the magnetization (5.15). We find,

$$m = \tanh(\beta B + \beta J q m) \quad (5.18)$$

We can now solve this equation to find the magnetization for various values of  $T$  and  $B$ :  $m = m(T, B)$ . It is simple to see the nature of the solutions using graphical methods.

### **B=0**

Let's first consider the situation with vanishing magnetic field,  $B = 0$ . The figures above show the graph linear in  $m$  compared with the tanh function. Since  $\tanh x \approx x - \frac{1}{3}x^3 + \dots$ , the slope of the graph near the origin is given by  $\beta J q$ . This then determines the nature of the solution.

- The first graph depicts the situation for  $\beta J q < 1$ . The only solution is  $m = 0$ . This means that at high temperatures  $k_B T > J q$ , there is no average magnetization of the system. The entropy associated to the random temperature fluctuations wins over the energetically preferred ordered state in which the spins align.
- The second graph depicts the situation for  $\beta J q > 1$ . Now there are three solutions:  $m = \pm m_0$  and  $m = 0$ . It will turn out that the middle solution,  $m = 0$ , is unstable. (This solution is entirely analogous to the unstable solution of the van der Waals equation. We will see this below when we compute the free energy).

For the other two possible solutions,  $m = \pm m_0$ , the magnetization is non-zero. Here we see the effects of the interactions begin to win over temperature. Notice that in the limit of vanishing temperature,  $\beta \rightarrow \infty$ ,  $m_0 \rightarrow 1$ . This means that all the spins are pointing in the same direction (either up or down) as expected.

- The critical temperature separating these two cases is

$$k_B T_c = Jq \tag{5.19}$$

The results described above are perhaps rather surprising. Based on the intuition that things in physics always happen smoothly, one might have thought that the magnetization would drop slowly to zero as  $T \rightarrow \infty$ . But that doesn't happen. Instead the magnetization turns off abruptly at some finite value of the temperature  $T = T_c$ , with no magnetization at all for higher temperatures. This is the characteristic behaviour of a phase transition.

### **$B \neq 0$**

For  $B \neq 0$ , we can solve the consistency equation (5.18) in a similar fashion. There are a couple of key differences to the  $B = 0$  case. Firstly, there is now no phase transition at fixed  $B$  as we vary temperature  $T$ . Instead, for very large temperatures  $k_B T \gg Jq$ , the magnetization goes smoothly to zero as

$$m \rightarrow \frac{B}{k_B T} \quad \text{as } T \rightarrow \infty$$

At low temperatures, the magnetization again asymptotes to the state  $m \rightarrow \pm 1$  which minimizes the energy. Except this time, there is no ambiguity as to whether the system chooses  $m = +1$  or  $m = -1$ . This is entirely determined by the sign of the magnetic field  $B$ .

In fact the low temperature behaviour requires slightly more explanation. For small values of  $B$  and  $T$ , there are again three solutions to (5.18). This follows simply from continuity: there are three solutions for  $T < T_c$  and  $B = 0$  shown in Figure 44 and these must survive in some neighbourhood of  $B = 0$ . One of these solutions is again unstable. However, of the remaining two only one is now stable: that with  $\text{sign}(m) = \text{sign}(B)$ . The other is meta-stable. We will see why this is the case shortly when we come to discuss the free energy.

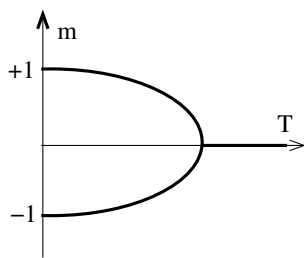

**Figure 46:** Magnetization with  $B = 0$  and the phase transition

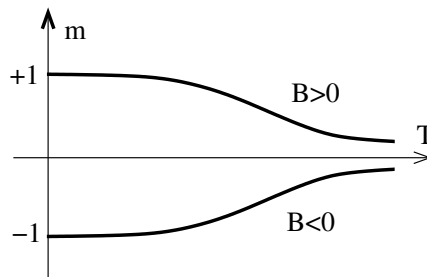

**Figure 47:** Magnetization at  $B \neq 0$ .

The net result of our discussion is depicted in the figures above. When  $B = 0$  there is a phase transition at  $T = T_c$ . For  $T < T_c$ , the system can sit in one of two magnetized states with  $m = \pm m_0$ . In contrast, for  $B \neq 0$ , there is no phase transition as we vary temperature and the system has at all times a preferred magnetization whose sign is determined by that of  $B$ . Notice however, we do have a phase transition if we fix temperature at  $T < T_c$  and vary  $B$  from negative to positive. Then the magnetization jumps discontinuously from a negative value to a positive value. Since the magnetization is a first derivative of the free energy (5.15), this is a first order phase transition. In contrast, moving along the temperature axis at  $B = 0$  results in a second order phase transition at  $T = T_c$ .

### 5.2.2 Critical Exponents

It is interesting to compare the phase transition of the Ising model with that of the liquid-gas phase transition. The two are sketched in the Figure 48 above. In both cases, we have a first order phase transition and a quantity jumps discontinuously at  $T < T_c$ . In the case of the liquid-gas, it is the density  $\rho = 1/v$  that jumps as we vary pressure; in the case of the Ising model it is the magnetization  $m$  that jumps as we vary the magnetic field. Moreover, in both cases the discontinuity disappears as we approach  $T = T_c$ .

We can calculate critical exponents for the Ising model. To compare with our discussion for the liquid-gas critical point, we will compute three quantities. First, consider the magnetization at  $B = 0$ . We can ask how this magnetization decreases as we tend towards the critical point. Just below  $T = T_c$ ,  $m$  is small and we can Taylor expand (5.18) to get

$$m \approx \beta J q m - \frac{1}{3}(\beta J q m)^3 + \dots$$

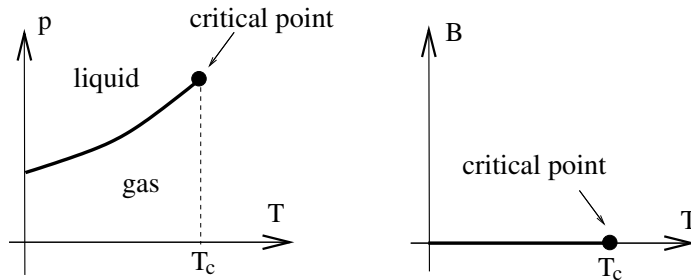

**Figure 48:** A comparison of the phase diagram for the liquid-gas system and the Ising model.

The magnetization therefore scales as

$$m_0 \sim \pm(T_c - T)^{1/2} \quad (5.20)$$

This is to be compared with the analogous result (5.9) from the van der Waals equation. We see that the values of the exponents are the same in both cases. Notice that the derivative  $dm/dT$  becomes infinite as we approach the critical point. In fact, we had already anticipated this when we drew the plot of the magnetization in Figure 45.

Secondly, we can sit at  $T = T_c$  and ask how the magnetization changes as we approach  $B = 0$ . We can read this off from (5.18). At  $T = T_c$  we have  $\beta Jq = 1$  and the consistency condition becomes reads  $m = \tanh(B/Jq + m)$ . Expanding for small  $B$  gives

$$m \approx \frac{B}{Jq} + m - \frac{1}{3} \left( \frac{B}{Jq} + m \right)^3 + \dots \approx \frac{B}{Jq} + m - \frac{1}{3} m^3 + \mathcal{O}(B^2)$$

So we find that the magnetization scales as

$$m \sim B^{1/3} \quad (5.21)$$

Notice that this power of 1/3 is again familiar from the liquid-gas transition (5.10) where the van der Waals equation gave  $v_{\text{gas}} - v_{\text{liquid}} \sim (p - p_c)^{1/3}$ .

Finally, we can look at the magnetic susceptibility  $\chi$ , defined as

$$\chi = N \left. \frac{\partial m}{\partial B} \right|_T$$

This is analogous to the compressibility  $\kappa$  of the gas. We will ask how  $\chi$  changes as we approach  $T \rightarrow T_c$  from above at  $B = 0$ . We differentiate (5.18) with respect to  $B$  to get

$$\chi = \frac{N\beta}{\cosh^2 \beta Jq m} \left( 1 + \frac{Jq}{N} \chi \right)$$

We now evaluate this at  $B = 0$ . Since we want to approach  $T \rightarrow T_c$  from above, we can also set  $m = 0$  in the above expression. Evaluating this at  $B = 0$  gives us the scaling

$$\chi = \frac{N\beta}{1 - Jq\beta} \sim (T - T_c)^{-1} \quad (5.22)$$

Once again, we see that same critical exponent that the van der Waals equation gave us for the gas (5.12).

### 5.2.3 Validity of Mean Field Theory

The phase diagram and critical exponents above were all derived using the mean field approximation. But this was an unjustified approximation. Just as for the van der Waals equation, we can ask the all-important question: are our results right?

There is actually a version of the Ising model for which the mean field theory is exact: it is the  $d = \infty$  dimensional lattice. This is unphysical (even for a string theorist). Roughly speaking, mean field theory works for large  $d$  because each spin has a large number of neighbours and so indeed sees something close to the average spin.

But what about dimensions of interest? Mean field theory gets things most dramatically wrong in  $d = 1$ . In that case, no phase transition occurs. We will derive this result below where we briefly describe the exact solution to the  $d = 1$  Ising model. There is a general lesson here: in low dimensions, both thermal and quantum fluctuations are more important and invariably stop systems forming ordered phases.

In higher dimensions,  $d \geq 2$ , the crude features of the phase diagram, including the existence of a phase transition, given by mean field theory are essentially correct. In fact, the very existence of a phase transition is already worthy of comment. The defining feature of a phase transition is behaviour that jumps discontinuously as we vary  $\beta$  or  $B$ . Mathematically, the functions must be non-analytic. Yet all properties of the theory can be extracted from the partition function  $Z$  which is a sum of smooth, analytic functions (5.14). How can we get a phase transition? The loophole is that  $Z$  is only necessarily analytic if the sum is finite. But there is no such guarantee that when the number of lattice sites  $N \rightarrow \infty$ . We reach a similar conclusion to that of Bose-Einstein condensation: phase transitions only strictly happen in the thermodynamic limit. There are no phase transitions in finite systems.

What about the critical exponents that we computed in (5.20), (5.21) and (5.22)? It turns out that these are correct for the Ising model defined in  $d \geq 4$ . (We will briefly sketch why this is true at the end of this Chapter). But for  $d = 2$  and  $d = 3$ , the critical exponents predicted by mean field theory are only first approximations to the true answers.

For  $d = 2$ , the exact solution (which goes quite substantially past this course) gives the critical exponents to be,

$$\begin{aligned} m_0 &\sim (T_c - T)^\beta && \text{with } \beta = \frac{1}{8} \\ m &\sim B^{1/\delta} && \text{with } \delta = \frac{15}{7} \\ \chi &\sim (T - T_c)^{-\gamma} && \text{with } \gamma = \frac{7}{4} \end{aligned}$$

The biggest surprise is in  $d = 3$  dimensions. Here the critical exponents are not known exactly. However, there has been a great deal of numerical work to determine them. They are given by

$$\beta \approx 0.32 \quad , \quad \delta \approx 4.8 \quad , \quad \gamma \approx 1.2$$

But these are exactly the same critical exponents that are seen in the liquid-gas phase transition. That's remarkable! We saw above that the mean field approach to the Ising model gave the same critical exponents as the van der Waals equation. But they are both wrong. And they are both wrong in the same, complicated, way! Why on earth would a system of spins on a lattice have anything to do with the phase transition between a liquid and gas? It is as if all memory of the microscopic physics — the type of particles, the nature of the interactions — has been lost at the critical point. And that's exactly what happens.

What we're seeing here is evidence for *universality*. There is a single theory which describes the physics at the critical point of the liquid gas transition, the 3d Ising model and many other systems. This is a theoretical physicist's dream! We spend a great deal of time trying to throw away the messy details of a system to focus on the elegant essentials. But, at a critical point, Nature does this for us! Although critical points in two dimensions are well understood, there is still much that we don't know about critical points in three dimensions. This, however, is a story that will have to wait for another day.

### 5.3 Some Exact Results for the Ising Model

This subsection is something of a diversion from our main interest. In later subsections, we will develop the idea of mean field theory. But first we pause to describe some exact results for the Ising model using techniques that do not rely on the mean field approximation. Many of the results that we derive have broader implications for systems beyond the Ising model.



As we mentioned above, there is an exact solution for the Ising model in  $d = 1$  dimension and, when  $B = 0$ , in  $d = 2$  dimensions. Here we will describe the  $d = 1$  solution but not the full  $d = 2$  solution. We will, however, derive a number of results for the  $d = 2$  Ising model which, while falling short of the full solution, nonetheless provide important insights into the physics.

### 5.3.1 The Ising Model in $d = 1$ Dimensions

We start with the *Ising chain*, the Ising model on a one dimensional line. Here we will see that the mean field approximation fails miserably, giving qualitatively incorrect results: the exact results shows that there are no phase transitions in the Ising chain.

The energy of the system (5.13) can be trivially rewritten as

$$E = -J \sum_{i=1}^N s_i s_{i+1} - \frac{B}{2} \sum_{i=1}^N (s_i + s_{i+1})$$

We will impose periodic boundary conditions, so the spins live on a circular lattice with  $s_{N+1} \equiv s_1$ . The partition function is then

$$Z = \sum_{s_1=\pm 1} \dots \sum_{s_N=\pm 1} \prod_{i=1}^N \exp \left( \beta J s_i s_{i+1} + \frac{\beta B}{2} (s_i + s_{i+1}) \right) \quad (5.23)$$

The crucial observation that allows us to solve the problem is that this partition function can be written as a product of matrices. We adopt notation from quantum mechanics and define the  $2 \times 2$  matrix,

$$\langle s_i | T | s_{i+1} \rangle \equiv \exp \left( \beta J s_i s_{i+1} + \frac{\beta B}{2} (s_i + s_{i+1}) \right) \quad (5.24)$$

The row of the matrix is specified by the value of  $s_i = \pm 1$  and the column by  $s_{i+1} = \pm 1$ .  $T$  is known as the *transfer matrix* and, in more conventional notation, is given by

$$T = \begin{pmatrix} e^{\beta J + \beta B} & e^{-\beta J} \\ e^{-\beta J} & e^{\beta J - \beta B} \end{pmatrix}$$

The sums over the spins  $\sum_{s_i}$  and product over lattice sites  $\prod_i$  in (5.23) simply tell us to multiply the matrices defined in (5.24) and the partition function becomes

$$Z = \text{Tr} (\langle s_1 | T | s_2 \rangle \langle s_2 | T | s_3 \rangle \dots \langle s_N | T | s_1 \rangle) = \text{Tr} T^N \quad (5.25)$$

where the trace arises because we have imposed periodic boundary conditions. To complete the story, we need only compute the eigenvalues of  $T$  to determine the partition function. A quick calculation shows that the two eigenvalues of  $T$  are

$$\lambda_{\pm} = e^{\beta J} \cosh \beta B \pm \sqrt{e^{2\beta J} \cosh^2 \beta B - 2 \sinh 2\beta J} \quad (5.26)$$

where, clearly,  $\lambda_- < \lambda_+$ . The partition function is then

$$Z = \lambda_+^N + \lambda_-^N = \lambda_+^N \left( 1 + \frac{\lambda_-^N}{\lambda_+^N} \right) \approx \lambda_+^N \quad (5.27)$$

where, in the last step, we've used the simple fact that if  $\lambda_+$  is the largest eigenvalue then  $\lambda_-^N/\lambda_+^N \approx 0$  for very large  $N$ .

The partition function  $Z$  contains many quantities of interest. In particular, we can use it to compute the magnetisation as a function of temperature when  $B = 0$ . This, recall, is the quantity which is predicted to undergo a phase transition in the mean field approximation, going abruptly to zero at some critical temperature. In the  $d = 1$  Ising model, the magnetisation is given by

$$m = \frac{1}{N\beta} \left. \frac{\partial \log Z}{\partial B} \right|_{B=0} = \frac{1}{\lambda_+ \beta} \left. \frac{\partial \lambda_+}{\partial B} \right|_{B=0} = 0$$

We see that the true physics for  $d = 1$  is very different than that suggested by the mean field approximation. When  $B = 0$ , there is no magnetisation! While the  $J$  term in the energy encourages the spins to align, this is completely overwhelmed by thermal fluctuations for any value of the temperature.

There is a general lesson in this calculation: thermal fluctuations always win in one dimensional systems. They never exhibit ordered phases and, for this reason, never exhibit phase transitions. The mean field approximation is bad in one dimension.

### 5.3.2 2d Ising Model: Low Temperatures and Peierls Droplets

Let's now turn to the Ising model in  $d = 2$  dimensions. We'll work on a square lattice and set  $B = 0$ . Rather than trying to solve the model exactly, we'll have more modest goals. We will compute the partition function in two different limits: high temperature and low temperature. We start here with the low temperature expansion.

The partition function is given by the sum over all states, weighted by  $e^{-\beta E}$ . At low temperatures, this is always dominated by the lowest lying states. For the Ising model,

we have

$$Z = \sum_{\{s_i\}} \exp \left( \beta J \sum_{\langle ij \rangle} s_i s_j \right)$$

The low temperature limit is  $\beta J \rightarrow \infty$ , where the partition function can be approximated by the sum over the first few lowest energy states. All we need to do is list these states.

The ground states are easy. There are two of them: spins all up or spins all down. For example, the ground state with spins all up looks like

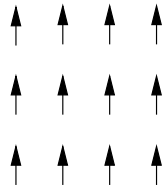

Each of these ground states has energy  $E = E_0 = -2NJ$ .

The first excited states arise by flipping a single spin. Each spin has  $q = 4$  nearest neighbours – denoted by red lines in the example below – each of which leads to an energy cost of  $2J$ . The energy of each first excited state is therefore  $E_1 = E_0 + 8J$ .

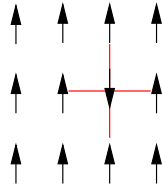

There are, of course,  $N$  different spins that we we can flip and, correspondingly, the first energy level has a degeneracy of  $N$ .

To proceed, we introduce a diagrammatic method to list the different states. We draw only the “broken” bonds which connect two spins with opposite orientation and, as in the diagram above, denote these by red lines. We further draw the flipped spins as red dots, the unflipped spins as blue dots. The energy of the state is determined simply by the number of red lines in the diagram. Pictorially, we write the first excited state as

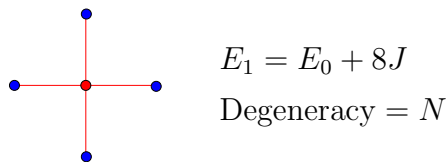

The next lowest state has six broken bonds. It takes the form

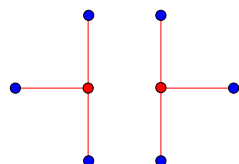

$$E_2 = E_0 + 12J$$

$$\text{Degeneracy} = 2N$$

where the extra factor of 2 in the degeneracy comes from the two possible orientations (vertical and horizontal) of the graph.

Things are more interesting for the states which sit at the third excited level. These have 8 broken bonds. The simplest configuration consists of two, disconnected, flipped spins

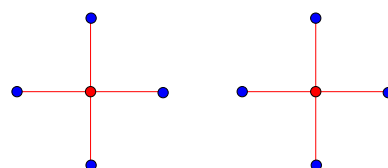

$$E_3 = E_0 + 16J$$

$$\text{Degeneracy} = \frac{1}{2}N(N - 5) \tag{5.28}$$

The factor of  $N$  in the degeneracy comes from placing the first graph; the factor of  $N - 5$  arises because the flipped spin in the second graph can sit anywhere apart from on the five vertices used in the first graph. Finally, the factor of  $1/2$  arises from the interchange of the two graphs.

There are also three further graphs with the same energy  $E_3$ . These are

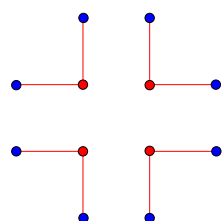

$$E_3 = E_0 + 16J$$

$$\text{Degeneracy} = N$$

and

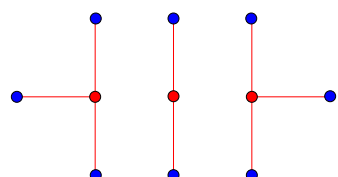

$$E_3 = E_0 + 16J$$

$$\text{Degeneracy} = 2N$$

where the degeneracy comes from the two orientations (vertical and horizontal). And, finally,

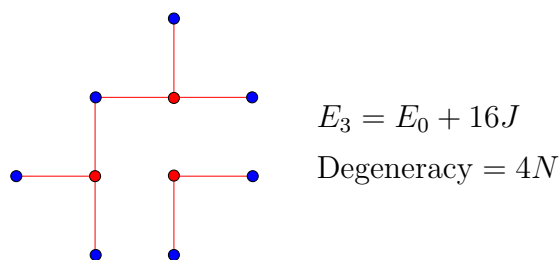

where the degeneracy comes from the four orientations (rotating the graph by  $90^\circ$ ).

Adding all the graphs above together gives us an expansion of the partition function in power of  $e^{-\beta J} \ll 1$ . This is

$$Z = 2e^{2N\beta J} \left( 1 + Ne^{-8\beta J} + 2Ne^{-12\beta J} + \frac{1}{2}(N^2 + 9N)e^{-16\beta J} + \dots \right) \quad (5.29)$$

where the overall factor of 2 originates from the two ground states of the system. We'll make use of the specific coefficients in this expansion in Section 5.3.4. Before we focus on the physics hiding in the low temperature expansion, it's worth making a quick comment that something quite nice happens if we take the log of the partition function,

$$\log Z = \log 2 + 2N\beta J + Ne^{-8\beta J} + 2Ne^{-12\beta J} + \frac{9}{2}Ne^{-16\beta J} + \dots$$

The thing to notice is that the  $N^2$  term in the partition function (5.29) has cancelled out and  $\log Z$  is proportional to  $N$ , which is to be expected since the free energy of the system is extensive. Looking back, we see that the  $N^2$  term was associated to the disconnected diagrams in (5.28). There is actually a general lesson hiding here: the partition function can be written as the exponential of the sum of connected diagrams. We saw exactly the same issue arise in the cluster expansion in (2.37).

### Peierls Droplets

Continuing the low temperature expansion provides a heuristic, but physically intuitive, explanation for why phase transitions happen in  $d \geq 2$  dimensions but not in  $d = 1$ . As we flip more and more spins, the low energy states become *droplets*, consisting of a region of space in which all the spins are flipped, surrounded by a larger sea in which the spins have their original alignment. The energy cost of such a droplet is roughly

$$E \sim 2JL$$

where  $L$  is the perimeter of the droplet. Notice that the energy does not scale as the area of the droplet since all spins inside are aligned with their neighbours. It is only those on the edge which are misaligned and this is the reason for the perimeter scaling. To understand how these droplets contribute to the partition function, we also need to know their degeneracy. We will now argue that the degeneracy of droplets scales as

$$\text{Degeneracy} \sim e^{\alpha L}$$

for some value of  $\alpha$ . To see this, consider firstly the problem of a random walk on a 2d square lattice. At each step, we can move in one of four directions. So the number of paths of length  $L$  is

$$\#\text{paths} \sim 4^L = e^{L \log 4}$$

Of course, the perimeter of a droplet is more constrained than a random walk. Firstly, the perimeter can't go back on itself, so it really only has three directions that it can move in at each step. Secondly, the perimeter must return to its starting point after  $L$  steps. And, finally, the perimeter cannot self-intersect. One can show that the number of paths that obey these conditions is

$$\#\text{paths} \sim e^{\alpha L}$$

where  $\log 2 < \alpha < \log 3$ . Since the degeneracy scales as  $e^{\alpha L}$ , the entropy of the droplets is proportional to  $L$ .

The fact that both energy and entropy scale with  $L$  means that there is an interesting competition between them. At temperatures where the droplets are important, the partition function is schematically of the form

$$Z \sim \sum_L e^{\alpha L} e^{-2\beta J L}$$

For large  $\beta$  (i.e. low temperature) the partition function converges. However, as the temperature increases, one reaches the critical temperature

$$k_B T_c \approx \frac{2J}{\alpha} \tag{5.30}$$

where the partition function no longer converges. At this point, the entropy wins over the energy cost and it is favourable to populate the system with droplets of arbitrary sizes. This is how one sees the phase transition in the partition function. For temperature above  $T_c$ , the low-temperature expansion breaks down and the ordered magnetic phase is destroyed.

We can also use the droplet argument to see why phase transitions don't occur in  $d = 1$  dimension. On a line, the boundary of any droplet always consists of just two points. This means that the energy cost to forming a droplet is always  $E = 2J$ , regardless of the size of the droplet. But, since the droplet can exist anywhere along the line, its degeneracy is  $N$ . The net result is that the free energy associated to creating a droplet scales as

$$F \sim 2J - k_B T \log N$$

and, as  $N \rightarrow \infty$ , the free energy is negative for any  $T > 0$ . This means that the system will prefer to create droplets of arbitrary length, randomizing the spins. This is the intuitive reason why there is no magnetic ordered phase in the  $d = 1$  Ising model.

### 5.3.3 2d Ising Model: High Temperatures

We now turn to the 2d Ising model in the opposite limit of high temperature. Here we expect the partition function to be dominated by the completely random, disordered configurations of maximum entropy. Our goal is to find a way to expand the partition function in  $\beta J \ll 1$ .

We again work with zero magnetic field,  $B = 0$  and write the partition function as

$$Z = \sum_{\{s_i\}} \exp \left( \beta J \sum_{\langle ij \rangle} s_i s_j \right) = \sum_{\{s_i\}} \prod_{\langle ij \rangle} e^{\beta J s_i s_j}$$

There is a useful way to rewrite  $e^{\beta J s_i s_j}$  which relies on the fact that the product  $s_i s_j$  only takes  $\pm 1$ . It doesn't take long to check the following identity:

$$\begin{aligned} e^{\beta J s_i s_j} &= \cosh \beta J + s_i s_j \sinh \beta J \\ &= \cosh \beta J (1 + s_i s_j \tanh \beta J) \end{aligned}$$

Using this, the partition function becomes

$$\begin{aligned} Z &= \sum_{\{s_i\}} \prod_{\langle ij \rangle} \cosh \beta J (1 + s_i s_j \tanh \beta J) \\ &= (\cosh \beta J)^{qN/2} \sum_{\{s_i\}} \prod_{\langle ij \rangle} (1 + s_i s_j \tanh \beta J) \end{aligned} \tag{5.31}$$

where the number of nearest neighbours is  $q = 4$  for the 2d square lattice.

With the partition function in this form, there is a natural expansion which suggests itself. At high temperatures  $\beta J \ll 1$  which, of course, means that  $\tanh \beta J \ll 1$ . But the partition function is now naturally a product of powers of  $\tanh \beta J$ . This is somewhat analogous to the cluster expansion for the interacting gas that we met in Section 2.5.3. As in the cluster expansion, we will represent the expansion graphically.

We need no graphics for the leading order term. It has no factors of  $\tanh \beta J$  and is simply

$$Z \approx (\cosh \beta J)^{2N} \sum_{\{s_i\}} 1 = 2^N (\cosh \beta J)^{2N}$$

That's simple.

Let's now turn to the leading correction. Expanding the partition function (5.31), each power of  $\tanh \beta J$  is associated to a nearest neighbour pair  $\langle ij \rangle$ . We'll represent this by drawing a line on the lattice:

$$i \circ \text{---} \circ j = s_i s_j \tanh \beta J$$

But there's a problem: each factor of  $\tanh \beta J$  in (5.31) also comes with a sum over all spins  $s_i$  and  $s_j$ . And these are  $+1$  and  $-1$  which means that they simply sum to zero,

$$\sum_{s_i, s_j} s_i s_j = +1 - 1 - 1 + 1 = 0$$

How can we avoid this? The only way is to make sure that we're summing over an even number of spins on each site, since then we get factors of  $s_i^2 = 1$  and no cancellations. Graphically, this means that every site must have an even number of lines attached to it. The first correction is then of the form

$$\begin{array}{c}
 \circ 1 \text{---} \circ 2 \\
 | \quad | \\
 \circ 3 \text{---} \circ 4
 \end{array}
 = (\tanh \beta J)^4 \sum_{\{s_i\}} s_1 s_2 s_2 s_3 s_3 s_4 s_4 s_1 = 2^4 (\tanh \beta J)^4$$

There are  $N$  such terms since the upper left corner of the square can be on any one of the  $N$  lattice sites. (Assuming periodic boundary conditions for the lattice). So including the leading term and first correction, we have

$$Z = 2^N (\cosh \beta J)^{2N} (1 + N(\tanh \beta J)^4 + \dots)$$

We can go further. The next terms arise from graphs of length 6 and the only possibilities are rectangles, oriented as either landscape or portrait. Each of them can sit on



one of  $N$  sites, giving a contribution

$$\begin{array}{|c|c|c|} \hline \circ & \circ & \circ \\ \hline \circ & \circ & \circ \\ \hline \end{array} + \begin{array}{|c|c|} \hline \circ & \circ \\ \hline \circ & \circ \\ \hline \circ & \circ \\ \hline \end{array} = 2N(\tanh \beta J)^4$$

Things get more interesting when we look at graphs of length 8. We have four different types of graphs. Firstly, there are the trivial, disconnected pair of squares

$$\begin{array}{|c|c|} \hline \circ & \circ \\ \hline \circ & \circ \\ \hline \end{array} \quad \begin{array}{|c|c|} \hline \circ & \circ \\ \hline \circ & \circ \\ \hline \end{array} = \frac{1}{2}N(N-5)(\tanh \beta J)^8$$

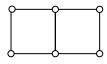
Here the first factor of  $N$  is the possible positions of the first square; the factor of  $N-5$  arises because the possible location of the upper corner of the second square can't be on any of the vertices of the first, but nor can it be on the square one to the left of the upper corner of the first since that would give a graph that looks like  which has three lines coming off the middle site and therefore vanishes when we sum over spins. Finally, the factor of  $1/2$  comes because the two squares are identical.

The other graphs of length 8 are a large square, a rectangle and a corner. The large square gives a contribution

$$\begin{array}{|c|c|c|} \hline \circ & \circ & \circ \\ \hline \circ & \circ & \circ \\ \hline \circ & \circ & \circ \\ \hline \end{array} = N(\tanh \beta J)^8$$

There are two orientations for the rectangle. Including these gives a factor of 2,

$$\begin{array}{|c|c|c|c|} \hline \circ & \circ & \circ & \circ \\ \hline \circ & \circ & \circ & \circ \\ \hline \end{array} = 2N(\tanh \beta J)^8$$

Finally, the corner graph has four orientations, giving

$$\begin{array}{|c|c|} \hline \circ & \circ \\ \hline \circ & \circ \\ \hline \circ & \circ \\ \hline \end{array} = 4N(\tanh \beta J)^8$$

Adding all contributions together gives us the first few terms in high temperature expansion of the partition function

$$\begin{aligned} Z = 2^N (\cosh \beta J)^{2N} & \left( 1 + N(\tanh \beta J)^4 + 2N(\tanh \beta J)^6 \right. \\ & \left. + \frac{1}{2}(N^2 + 9N)(\tanh \beta J)^8 + \dots \right) \end{aligned} \quad (5.32)$$

There's some magic hiding in this expansion which we'll turn to in Section 5.3.4. First, let's just see how the high energy expansion plays out in the  $d = 1$  dimensional Ising model.

### The Ising Chain Revisited

Let's do the high temperature expansion for the  $d = 1$  Ising chain with periodic boundary conditions and  $B = 0$ . We have the same partition function (5.31) and the same issue that only graphs with an even number of lines attached to each vertex contribute. But, for the Ising chain, there is only one such term: it is the closed loop. This means that the partition function is

$$Z = 2^N (\cosh \beta J)^N (1 + (\tanh \beta J)^N)$$

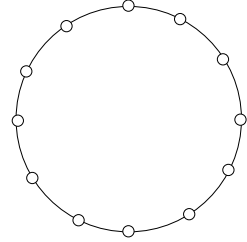

**Figure 49:**

In the limit  $N \rightarrow \infty$ ,  $(\tanh \beta J)^N \rightarrow 0$  at high temperatures and even the contribution from the closed loop vanishes. We're left with

$$Z = (2 \cosh \beta J)^N$$

This agrees with our exact result for the Ising chain given in (5.27), which can be seen by setting  $B = 0$  in (5.26) so that  $\lambda_+ = 2 \cosh \beta J$ .

### 5.3.4 Kramers-Wannier Duality

In the previous sections we computed the partition function perturbatively in two extreme regimes of low temperature and high temperature. The physics in the two cases is, of course, very different. At low temperatures, the partition function is dominated by the lowest energy states; at high temperatures it is dominated by maximally disordered states. Yet comparing the partition functions at low temperature (5.29) and high temperature (5.32) reveals an extraordinary fact: the expansions are the same! More concretely, the two series agree if we exchange

$$e^{-2\beta J} \longleftrightarrow \tanh \beta J \tag{5.33}$$

Of course, we've only checked the agreement to the first few orders in perturbation theory. Below we shall prove that this miracle continues to all orders in perturbation theory. The symmetry of the partition function under the interchange (5.33) is known as *Kramers-Wannier duality*. Before we prove this duality, we will first just assume that it is true and extract some consequences.

We can express the statement of the duality more clearly. The Ising model at temperature  $\beta$  is related to the same model at temperature  $\tilde{\beta}$ , defined as

$$e^{-2\tilde{\beta}J} = \tanh \beta J \quad (5.34)$$

This way of writing things hides the symmetry of the transformation. A little algebra shows that this is equivalent to

$$\sinh 2\tilde{\beta}J = \frac{1}{\sinh 2\beta J}$$

Notice that this is a hot/cold duality. When  $\beta J$  is large,  $\tilde{\beta}J$  is small. Kramers-Wannier duality is the statement that, when  $B = 0$ , the partition functions of the Ising model at two temperatures are related by

$$\begin{aligned} Z[\beta] &= \frac{2^N (\cosh \beta J)^{2N}}{2e^{2N\tilde{\beta}J}} Z[\tilde{\beta}] \\ &= 2^{N-1} (\cosh \beta J \sinh \beta J)^N Z[\tilde{\beta}] \end{aligned} \quad (5.35)$$

This means that if you know the thermodynamics of the Ising model at one temperature, then you also know the thermodynamics at the other temperature. Notice however, that it does not say that all the physics of the two models is equivalent. In particular, when one system is in the ordered phase, the other typically lies in the disordered phase.

One immediate consequence of the duality is that we can use it to compute the exact critical temperature  $T_c$ . This is the temperature at which the partition function is singular in the  $N \rightarrow \infty$  limit. (We'll discuss a more refined criterion in Section 5.4.3). If we further assume that there is just a single phase transition as we vary the temperature, then it must happen at the special self-dual point  $\beta = \tilde{\beta}$ . This is

$$k_B T = \frac{2J}{\log(\sqrt{2} + 1)} \approx 2.269 J$$

The exact solution of Onsager confirms that this is indeed the transition temperature. It's also worth noting that it's fully consistent with the more heuristic Peierls droplet argument (5.30) since  $\log 2 < \log(\sqrt{2} + 1) < \log 3$ .

### Proving the Duality

So far our evidence for the duality (5.35) lies in the agreement of the first few terms in the low and high temperature expansions (5.29) and (5.32). Of course, we could keep computing further and further terms and checking that they agree, but it would be nicer to simply prove the equality between the partition functions. We shall do so here.

The key idea that we need can actually be found by staring hard at the various graphs that arise in the two expansions. Eventually, you will realise that they are the same, albeit drawn differently. For example, consider the two “corner” diagrams

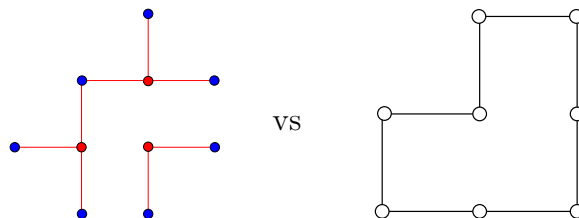

The two graphs are *dual*. The red lines in the first graph intersect the black lines in the second as can be seen by placing them on top of each other:

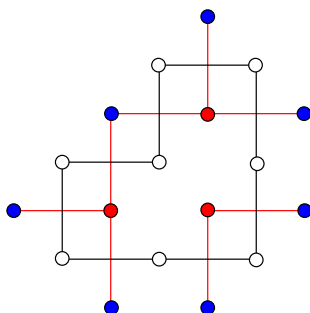

The same pattern occurs more generally: the graphs appearing in the low temperature expansion are in one-to-one correspondence with the dual graphs of the high temperature expansion. Here we will show how this occurs and how one can map the partition functions onto each other.

Let’s start by writing the partition function in the form (5.31) that we met in the high temperature expansion and presenting it in a slightly different way,

$$\begin{aligned} Z[\beta] &= \sum_{\{s_i\}} \prod_{\langle ij \rangle} (\cosh \beta J + s_i s_j \sinh \beta J) \\ &= \sum_{\{s_i\}} \prod_{\langle ij \rangle} \sum_{k_{ij}=0,1} C_{k_{ij}}[\beta J] (s_i s_j)^{k_{ij}} \end{aligned}$$

where we have introduced the rather strange variable  $k_{ij}$  associated to each nearest neighbour pair that takes values 0 and 1, together with the functions.

$$C_0[\beta J] = \cosh \beta J \quad \text{and} \quad C_1[\beta J] = \sinh \beta J$$

The variables in the original Ising model were spins on the lattice sites. The observation that the graphs which appear in the two expansions are dual suggests that it might be

profitable to focus attention on the links between lattice sites. Clearly, we have one link for every nearest neighbour pair. If we label these links by  $l$ , we can trivially rewrite the partition function as

$$Z = \sum_{k_l=0,1} \prod_l \sum_{\{s_i\}} C_{k_l}[\beta J] (s_i s_j)^{k_l}$$

Notice that the strange label  $k_{ij}$  has now become a variable that lives on the links  $l$  rather than the original lattice sites  $i$ .

At this stage, we do the sum over the spins  $s_i$ . We've already seen that if a given spin, say  $s_i$ , appears in a term an odd number of times, then that term will vanish when we sum over the spin. Alternatively, if the spin  $s_i$  appears an even number of times, then the sum will give 2. We'll say that a given link  $l$  is turned on in configurations with  $k_l = 1$  and turned off when  $k_l = 0$ . In this language, a term in the sum over spin  $s_i$  contributes only if an even number of links attached to site  $i$  are turned on. The partition function then becomes

$$Z = 2^N \sum_{k_l} \prod_l C_{k_l}[\beta J] \Big|_{\text{Constrained}} \quad (5.36)$$

Now we have something interesting. Rather than summing over spins on lattice sites, we're now summing over the new variables  $k_l$  living on links. This looks like the partition function of a totally different physical system, where the degrees of freedom live on the links of the original lattice. But there's a catch – that big “Constrained” label on the sum. This is there to remind us that we don't sum over all  $k_l$  configurations; only those for which an even number of links are turned on for every lattice site. And that's annoying. It's telling us that the  $k_l$  aren't really independent variables. There are some constraints that must be imposed.

Fortunately, for the 2d square lattice, there is a simple way to solve the constraint. We introduce yet more variables,  $\tilde{s}_i$  which, like the original spin variables, take values  $\pm 1$ . However, the  $\tilde{s}_i$  do not live on the original lattice sites. Instead, they live on the vertices of the dual lattice. For the 2d square lattice, the dual vertices are drawn in the figure. The original lattice sites are in white; the dual lattice sites in black.

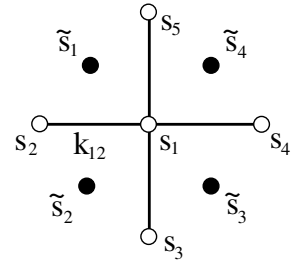

**Figure 50:**

The link variables  $k_l$  are related to the two nearest spin variables  $\tilde{s}_i$  as follows:

$$k_{12} = \frac{1}{2}(1 - \tilde{s}_1 \tilde{s}_2)$$

$$\begin{aligned}
k_{13} &= \frac{1}{2}(1 - \tilde{s}_2\tilde{s}_3) \\
k_{14} &= \frac{1}{2}(1 - \tilde{s}_3\tilde{s}_4) \\
k_{15} &= \frac{1}{2}(1 - \tilde{s}_1\tilde{s}_4)
\end{aligned}$$

Notice that we've replaced four variables  $k_l$  taking values 0, 1 with four variables  $\tilde{s}_i$  taking values  $\pm 1$ . Each set of variables gives  $2^4$  possibilities. However, the map is not one-to-one. It is not possible to construct for all values of  $k_l$  using the parameterization in terms of  $\tilde{s}_i$ . To see this, we need only look at

$$\begin{aligned}
k_{12} + k_{13} + k_{14} + k_{15} &= 2 - \frac{1}{2}(\tilde{s}_1\tilde{s}_2 + \tilde{s}_2\tilde{s}_3 + \tilde{s}_3\tilde{s}_4 + \tilde{s}_1\tilde{s}_4) \\
&= 2 - \frac{1}{2}(\tilde{s}_1 + \tilde{s}_3)(\tilde{s}_2 + \tilde{s}_4) \\
&= 0, 2, \text{ or } 4
\end{aligned}$$

In other words, the number of links that are turned on must be even. But that's exactly what we want! Writing the  $k_l$  in terms of the auxiliary spins  $\tilde{s}_i$  automatically solves the constraint that is imposed on the sum in (5.36). Moreover, it is simple to check that for every configuration  $\{k_l\}$  obeying the constraint, there are two configurations of  $\{\tilde{s}_i\}$ . This means that we can replace the constrained sum over  $\{k_l\}$  with an unconstrained sum over  $\{\tilde{s}_i\}$ . The only price we pay is an additional factor of  $1/2$ .

$$Z[\beta] = \frac{1}{2} 2^N \sum_{\{\tilde{s}_i\}} \prod_{\langle ij \rangle} C_{\frac{1}{2}(1-\tilde{s}_i\tilde{s}_j)}[\beta j]$$

Finally, we'd like to find a simple expression for  $C_0$  and  $C_1$  in terms of  $\tilde{s}_i$ . That's easy enough. We can write

$$\begin{aligned}
C_k[\beta J] &= \cosh \beta J \exp(k \log \tanh \beta J) \\
&= (\sinh \beta J \cosh \beta J)^{1/2} \exp\left(-\frac{1}{2}\tilde{s}_i\tilde{s}_j \log \tanh \beta J\right)
\end{aligned}$$

Substituting this into our newly re-written partition function gives

$$\begin{aligned}
Z[\beta] &= 2^{N-1} \sum_{\{\tilde{s}_i\}} \prod_{\langle ij \rangle} (\sinh \beta J \cosh \beta J)^{1/2} \exp\left(-\frac{1}{2}\tilde{s}_i\tilde{s}_j \log \tanh \beta J\right) \\
&= 2^{N-1} (\sinh \beta J \cosh \beta J)^N \sum_{\{\tilde{s}_i\}} \exp\left(-\frac{1}{2} \log \tanh \beta J \sum_{\langle ij \rangle} \tilde{s}_i\tilde{s}_j\right)
\end{aligned}$$

But this final form of the partition function in terms of the dual spins  $\tilde{s}_i$  has exactly the same functional form as the original partition function in terms of the spins  $s_i$ . More precisely, we can write

$$Z[\beta] = 2^{N-1} (\sinh 2\beta J)^N Z[\tilde{\beta}]$$

where

$$e^{-2\tilde{\beta}J} = \tanh \beta J$$

as advertised previously in (5.34). This completes the proof of Kramers-Wannier duality in the 2d Ising model on a square lattice.

The concept of *duality* of this kind is a major feature in much of modern theoretical physics. The key idea is that when the temperature gets large there may be a different set of variables in which a theory can be written where it appears to live at low temperature. The same idea often holds in quantum theories, where duality maps strong coupling problems to weak coupling problems.

The duality in the Ising model is special for two reasons: firstly, the new variables  $\tilde{s}_i$  are governed by the same Hamiltonian as the original variables  $s_i$ . We say that the Ising model is self-dual. In general, this need not be the case — the high temperature limit of one system could look like the low-temperature limit of a very different system. Secondly, the duality in the Ising model can be proven explicitly. For most systems, we have no such luck. Nonetheless, the idea that there may be dual variables in other, more difficult theories, is compelling. Commonly studied examples include the exchange particles and vortices in two dimensions, and electrons and magnetic monopoles in three dimensions.

## 5.4 Landau Theory

We saw in Sections 5.1 and 5.2 that the van der Waals equation and mean field Ising model gave the same (sometimes wrong!) answers for the critical exponents. This suggests that there should be a unified way to look at phase transitions. Such a method was developed by Landau. It is worth stressing that, as we saw above, the Landau approach to phase transitions often only gives qualitatively correct results. However, its advantage is that it is extremely straightforward and easy. (Certainly much easier than the more elaborate methods needed to compute critical exponents more accurately).

The Landau theory of phase transitions is based around the free energy. We will illustrate the theory using the Ising model and then explain how to extend it to different systems. The free energy of the Ising model in the mean field approximation is readily attainable from the partition function (5.17),

$$F = -\frac{1}{\beta} \log Z = \frac{1}{2} J N q m^2 - \frac{N}{\beta} \log (2 \cosh \beta B_{\text{eff}}) \quad (5.37)$$

So far in this course, we've considered only systems in equilibrium. The free energy, like all other thermodynamic potentials, has only been defined on equilibrium states. Yet the equation above can be thought of as an expression for  $F$  as a function of  $m$ . Of course, we could substitute in the equilibrium value of  $m$  given by solving (5.18), but it seems a shame to throw out  $F(m)$  when it is such a nice function. Surely we can put it to some use!

The key step in Landau theory is to treat the function  $F = F(T, V; m)$  seriously. This means that we are extending our viewpoint away from equilibrium states to a whole class of states which have a constant average value of  $m$ . If you want some words to drape around this, you could imagine some external magical power that holds  $m$  fixed. The free energy  $F(T, V; m)$  is then telling us the equilibrium properties in the presence of this magical power. Perhaps more convincing is what we do with the free energy in the absence of any magical constraint. We saw in Section 4 that equilibrium is guaranteed if we sit at the minimum of  $F$ . Looking at extrema of  $F$ , we have the condition

$$\frac{\partial F}{\partial m} = 0 \quad \Rightarrow \quad m = \tanh \beta B_{\text{eff}}$$

But that's precisely the condition (5.18) that we saw previously. Isn't that nice!

In the context of Landau theory,  $m$  is called an *order parameter*. When it takes non-zero values, the system has some degree of order (the spins have a preferred direction in which they point) while when  $m = 0$  the spins are randomised and happily point in any direction.

For any system of interest, Landau theory starts by identifying a suitable order parameter. This should be taken to be a quantity which vanishes above the critical temperature at which the phase transition occurs, but is non-zero below the critical temperature. Sometimes it is obvious what to take as the order parameter; other times less so. For the liquid-gas transition, the relevant order parameter is the difference in densities between the two phases,  $v_{\text{gas}} - v_{\text{liquid}}$ . For magnetic or electric systems, the order parameter is typically some form of magnetization (as for the Ising model) or



the polarization. For the Bose-Einstein condensate, superfluids and superconductors, the order parameter is more subtle and is related to off-diagonal long-range order in the one-particle density matrix<sup>10</sup>, although this is usually rather lazily simplified to say that the order parameter can be thought of as the macroscopic wavefunction  $|\psi|^2$ .

Starting from the existence of a suitable order parameter, the next step in the Landau programme is to write down the free energy. But that looks tricky. The free energy for the Ising model (5.37) is a rather complicated function and clearly contains some detailed information about the physics of the spins. How do we just write down the free energy in the general case? The trick is to assume that we can expand the free energy in an analytic power series in the order parameter. For this to be true, the order parameter must be small which is guaranteed if we are close to a critical point (since  $m = 0$  for  $T > T_c$ ). The nature of the phase transition is determined by the kind of terms that appear in the expansion of the free energy. Let's look at a couple of simple examples.

#### 5.4.1 Second Order Phase Transitions

We'll consider a general system (Ising model; liquid-gas; BEC; whatever) and denote the order parameter as  $m$ . Suppose that the expansion of the free energy takes the general form

$$F(T; m) = F_0(T) + a(T)m^2 + b(T)m^4 + \dots \quad (5.38)$$

One common reason why the free energy has this form is because the theory has a symmetry under  $m \rightarrow -m$ , forbidding terms with odd powers of  $m$  in the expansion. For example, this is the situation in the Ising model when  $B = 0$ . Indeed, if we expand out the free energy (5.37) for the Ising model for small  $m$  using  $\cosh x \approx 1 + \frac{1}{2}x^2 + \frac{1}{4!}x^4 + \dots$  and  $\log(1 + y) \approx y - \frac{1}{2}y^2 + \dots$  we get the general form above with explicit expressions for  $F_0(T)$ ,  $a(T)$  and  $b(T)$ ,

$$F_{Ising}(T; m) = -Nk_B T \log 2 + \left( \frac{NJq}{2}(1 - Jq\beta) \right) m^2 + \left( \frac{N\beta^3 J^4 q^4}{24} \right) m^4 + \dots$$

The leading term  $F_0(T)$  is unimportant for our story. We are interested in how the free energy changes with  $m$ . The condition for equilibrium is given by

$$\frac{\partial F}{\partial m} = 0 \quad (5.39)$$

But the solutions to this equation depend on the sign of the coefficients  $a(T)$  and

---

<sup>10</sup>See, for example, the book “*Quantum Liquids*” by Anthony Leggett

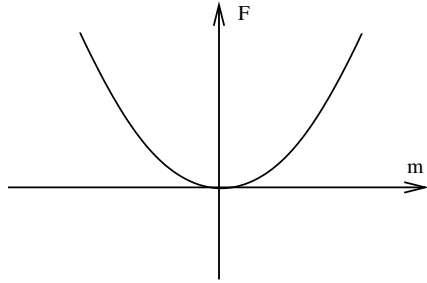

**Figure 51:** Free energy when  $a(T) > 0$

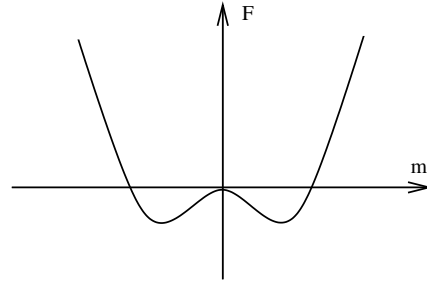

**Figure 52:** Free energy when  $a(T) < 0$

$b(T)$ . Moreover, this sign can change with temperature. This is the essence of the phase transitions. In the following discussion, we will assume that  $b(T) > 0$  for all  $T$ . (If we relax this condition, we have to also consider the  $m^6$  term in the free energy which leads to interesting results concerning so-called tri-critical points).

The two figures above show sketches of the free energy in the case where  $a(T) > 0$  and  $a(T) < 0$ . Comparing to the explicit free energy of the Ising model,  $a(T) < 0$  when  $T > T_c = Jq/k_B$  and  $a(T) > 0$  when  $T < T_c$ . When  $a(T) > 0$ , we have just a single equilibrium solution to (5.39) at  $m = 0$ . This is typically the situation at high temperatures. In contrast, at  $a(T) < 0$ , there are three solutions to (5.39). The solution  $m = 0$  clearly has higher free energy: this is now the unstable solution. The two stable solutions sit at  $m = \pm m_0$ . For example, if we choose to truncate the free energy (5.38) at quartic order, we have

$$m_0 = \sqrt{\frac{-a}{2b}} \quad T < T_c$$

If  $a(T)$  is a smooth function then the equilibrium value of  $m$  changes continuously from  $m = 0$  when  $a(T) > 0$  to  $m \neq 0$  at  $a(T) < 0$ . This describes a second order phase transition occurring at  $T_c$ , defined by  $a(T_c) = 0$ .

Once we know the equilibrium value of  $m$ , we can then substitute this back into the free energy  $F(T; m)$  in (5.38). This gives the thermodynamic free energy  $F(T)$  of the system in equilibrium that we have been studying throughout this course. For the quartic free energy, we have

$$F(T) = \begin{cases} F_0(T) & T > T_c \\ F_0(T) - a^2/2b & T < T_c \end{cases} \quad (5.40)$$

Because  $a(T_c) = 0$ , the equilibrium free energy  $F(T)$  is continuous at  $T = T_c$ . Moreover, the entropy  $S = -\partial F/\partial T$  is also continuous at  $T = T_c$ . However, if you differentiate the

equilibrium free energy twice, you will get a term  $a'^2/b$  which is generically not vanishing at  $T = T_c$ . This means that the heat capacity  $C = T\partial S/\partial T$  changes discontinuously at  $T = T_c$ , as befits a second order phase transition. A word of warning: if you want to compute equilibrium quantities such as the heat capacity, it's important that you first substitute in the equilibrium value of  $m$  and work with (5.40) rather than (5.38). If you don't, you miss the fact that the magnetization also changes with  $T$ .

We can easily compute critical exponents within the context of Landau theory. We need only make further assumptions about the behaviour of  $a(T)$  and  $b(T)$  in the vicinity of  $T_c$ . If we assume that near  $T = T_c$ , we can write

$$b(T) \approx b_0 \quad , \quad a(T) \approx a_0(T - T_c) \quad (5.41)$$

then we have

$$m_0 \approx \pm \sqrt{\frac{a_0}{2b_0}}(T_c - T)^{1/2} \quad T < T_c$$

which reproduces the critical exponent (5.9) and (5.20) that we derived for the van der Waals equation and Ising model respectively.

Notice that we didn't put any discontinuities into the free energy. Everything in  $F(T; m)$  was nice and smooth. When Taylor expanded, it has only integer powers of  $m$  and  $T$  as shown in (5.38) and (5.41). But the minima of  $F$  behave in a non-analytic fashion as seen in the expression for  $m_0$  above.

Landau's theory of phase transitions predicts this same critical exponent for all values of the dimension  $d$  of the system. But we've already mentioned in previous contexts that the critical exponent is in fact only correct for  $d \geq 4$ . We will understand how to derive this criterion from Landau theory in the next section.

## Spontaneous Symmetry Breaking

As we approach the end of the course, we're touching upon a number of ideas that become increasingly important in subsequent developments in physics. We already briefly met the idea of universality and critical phenomena. Here I would like to point out another very important idea: *spontaneous symmetry breaking*.

The free energy (5.38) is invariant under the  $\mathbf{Z}_2$  symmetry  $m \rightarrow -m$ . Indeed, we said that one common reason that we can expand the free energy only in even powers of  $m$  is that the underlying theory also enjoys this symmetry. But below  $T_c$ , the system must pick one of the two ground states  $m = +m_0$  or  $m = -m_0$ . Whichever choice it makes breaks the  $\mathbf{Z}_2$  symmetry. We say that the symmetry is spontaneously broken by the choice of ground state of the theory.

Spontaneous symmetry breaking has particularly dramatic consequences when the symmetry in question is continuous rather than discrete. For example, consider a situation where the order parameter is a complex number  $\psi$  and the free energy is given by (5.38) with  $m = |\psi|^2$ . (This is effectively what happens for BECs, superfluids and superconductors). Then we should only look at the  $m > 0$  solutions so that the ground state has  $|\psi|^2 = +m_0$ . But this leaves the phase of  $\psi$  completely undetermined. So there is now a continuous choice of ground states: we get to sit anywhere on the circle parameterised by the phase of  $\psi$ . Any choice that the system makes spontaneously breaks the  $U(1)$  rotational symmetry which acts on the phase of  $\psi$ . Some beautiful results due to Nambu and Goldstone show that much of the physics of these systems can be understood simply as a consequence of this symmetry breaking. The ideas of spontaneous symmetry breaking are crucial in both condensed matter physics and particle physics. In the latter context, it is intimately tied with the Higgs mechanism.

#### 5.4.2 First Order Phase Transitions

Let us now consider a situation where the expansion of the free energy also includes odd powers of the order parameter

$$F(T; m) = F_0(T) + \alpha(T)m + a(T)m^2 + \gamma(T)m^3 + b(T)m^4 + \dots$$

For example, this is the kind of expansion that we get for the Ising model free energy (5.37) when  $B \neq 0$ , which reads

$$F_{\text{Ising}}(T; m) = -Nk_B T \log 2 + \frac{JNq}{2}m^2 - \frac{N}{2k_B T}(B + Jqm)^2 + \frac{N}{24(k_B T)^3}(B + Jqm)^4 + \dots$$

Notice that there is no longer a symmetry relating  $m \rightarrow -m$ : the  $B$  field has a preference for one sign over the other.

If we again assume that  $b(T) > 0$  for all temperatures, the crude shape of the free energy graph again has two choices: there is a single minimum, or two minima and a local maximum.

Let's start at suitably low temperatures for which the situation is depicted in Figure 53. The free energy once again has a double well, except now slightly skewed. The local maximum is still an unstable point. But this time around, the minima with the lower free energy is preferred over the other one. This is the true ground state of the system. In contrast, the point which is locally, but not globally, a minimum corresponds to a meta-stable state of the system. In order for the system to leave this state, it must first fluctuate up and over the energy barrier separating the two.

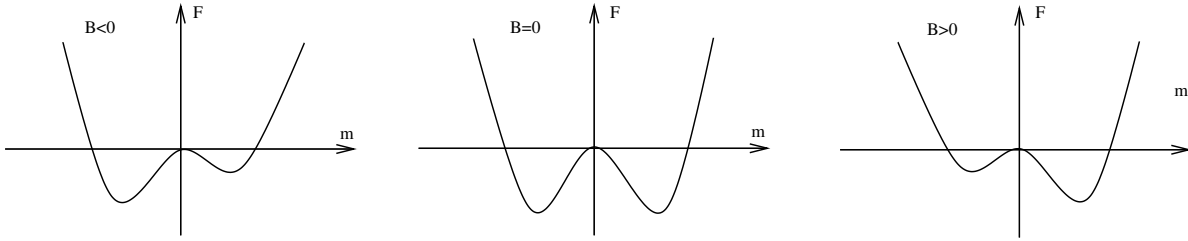

**Figure 53:** The free energy of the Ising model for  $B < 0$ ,  $B = 0$  and  $B > 0$ .

In this set-up, we can initiate a first order phase transition. This occurs when the coefficient of the odd terms,  $\alpha(T)$  and  $\gamma(T)$  change sign and the true ground state changes discontinuously from  $m < 0$  to  $m > 0$ . In some systems this behaviour occurs when changing temperature; in others it could occur by changing some external parameter. For example, in the Ising model the first order phase transition is induced by changing  $B$ .

At very high temperature, the double well potential is lost in favour of a single minimum as depicted in the figure to the right. There is a unique ground state, albeit shifted from  $m = 0$  by the presence of the  $\alpha(T)$  term above (which translates into the magnetic field  $B$  in the Ising model). The temperature at which the meta-stable ground state of the system is lost corresponds to the spinodal point in our discussion of the liquid-gas transition.

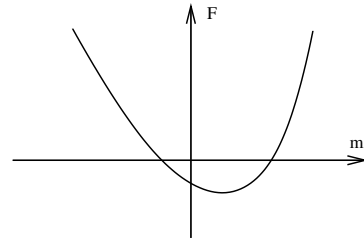

**Figure 54:**

One can play further games in Landau theory, looking at how the shape of the free energy can change as we vary temperature or other parameters. One can also use this framework to give a simple explanation of the concept of hysteresis. You can learn more about these from the links on the course webpage.

### 5.4.3 Lee-Yang Zeros

You may have noticed that the flavour of our discussion of phase transitions is a little different from the rest of the course. Until now, our philosophy was to derive everything from the partition function. But in this section, we dumped the partition function as soon as we could, preferring instead to work with the macroscopic variables such as the free energy. Why didn't we just stick with the partition function and examine phase transitions directly?

The reason, of course, is that the approach using the partition function is hard! In this short section, which is somewhat tangential to our main discussion, we will describe how phase transitions manifest themselves in the partition function.

For concreteness, let's go back to the classical interacting gas of Section 2.5, although the results we derive will be more general. We'll work in the grand canonical ensemble, with the partition function

$$\mathcal{Z}(z, V, T) = \sum_N z^N Z(N, V, T) = \sum_N \frac{z^N}{N! \lambda^{3N}} \int \prod_i d^3 r_i e^{-\beta \sum_{j < k} U(r_{jk})} \quad (5.42)$$

To regulate any potential difficulties with short distances, it is useful to assume that the particles have hard-cores so that they cannot approach to a distance less than  $r_0$ . We model this by requiring that the potential satisfies

$$U(r_{jk}) = 0 \quad \text{for} \quad r_{jk} < r_0$$

But this has an obvious consequence: if the particles have finite size, then there is a maximum number of particles,  $N_V$ , that we can fit into a finite volume  $V$ . (Roughly this number is  $N_V \sim V/r_0^3$ ). But that, in turn, means that the canonical partition function  $Z(N, V, T) = 0$  for  $N > N_V$ , and the grand partition function  $\mathcal{Z}$  is therefore a finite polynomial in the fugacity  $z$ , of order  $N_V$ . But if the partition function is a finite polynomial, there can't be any discontinuous behaviour associated with a phase transition. In particular, we can calculate

$$pV = k_B T \log \mathcal{Z} \quad (5.43)$$

which gives us  $pV$  as a smooth function of  $z$ . We can also calculate

$$N = z \frac{\partial}{\partial z} \log \mathcal{Z} \quad (5.44)$$

which gives us  $N$  as a function of  $z$ . Eliminating  $z$  between these two functions (as we did for both bosons and fermions in Section 3) tells us that pressure  $p$  is a smooth function of density  $N/V$ . We're never going to get the behaviour that we derived from the Maxwell construction in which the plot of pressure vs density shown in Figure 38 exhibits a discontinuous derivative.

The discussion above is just re-iterating a statement that we've alluded to several times already: there are no phase transitions in a finite system. To see the discontinuous behaviour, we need to take the limit  $V \rightarrow \infty$ . A theorem due to Lee and Yang<sup>11</sup> gives us a handle on the analytic properties of the partition function in this limit.

<sup>11</sup>This theorem was first proven for the Ising model in 1952. Soon afterwards, the same Lee and Yang proposed a model of parity violation in the weak interaction for which they won the 1957 Nobel prize.

The surprising insight of Lee and Yang is that if you're interested in phase transitions, you should look at the zeros of  $\mathcal{Z}$  in the complex  $z$ -plane. Let's firstly look at these when  $V$  is finite. Importantly, at finite  $V$  there can be no zeros on the positive real axis,  $z > 0$ . This follows from the definition of  $\mathcal{Z}$  given in (5.42) where it is a sum of positive quantities. Moreover, from (5.44), we can see that  $\mathcal{Z}$  is a monotonically increasing function of  $z$  because we necessarily have  $N > 0$ . Nonetheless,  $\mathcal{Z}$  is a polynomial in  $z$  of order  $N_V$  so it certainly has  $N_V$  zeros somewhere in the complex  $z$ -plane. Since  $\mathcal{Z}^*(z) = \mathcal{Z}(z^*)$ , these zeros must either sit on the real negative axis or come in complex pairs.

However, the statements above rely on the fact that  $\mathcal{Z}$  is a finite polynomial. As we take the limit  $V \rightarrow \infty$ , the maximum number of particles that we can fit in the system diverges,  $N_V \rightarrow \infty$ , and  $\mathcal{Z}$  is now defined as an infinite series. But infinite series can do things that finite ones can't. The Lee-Yang theorem says that as long as the zeros of  $\mathcal{Z}$  continue to stay away from the positive real axis as  $V \rightarrow \infty$ , then no phase transitions can happen. But if one or more zeros happen to touch the positive real axis, life gets more interesting.

More concretely, the Lee-Yang theorem states:

- **Lee-Yang Theorem:** The quantity

$$\Theta = \lim_{V \rightarrow \infty} \left( \frac{1}{V} \log \mathcal{Z}(z, V, T) \right)$$

exists for all  $z > 0$ . The result is a continuous, non-decreasing function of  $z$  which is independent of the shape of the box (up to some sensible assumptions such as Surface Area/ $V \sim V^{-1/3}$  which ensures that the box isn't some stupid fractal shape).

Moreover, let  $R$  be a fixed, volume independent, region in the complex  $z$  plane which contains part of the real, positive axis. If  $R$  contains no zero of  $\mathcal{Z}(z, V, T)$  for all  $z \in R$  then  $\Theta$  is an analytic function of  $z$  for all  $z \in R$ . In particular, all derivatives of  $\Theta$  are continuous.

In other words, there can be no phase transitions in the region  $R$  even in the  $V \rightarrow \infty$  limit. The last result means that, as long as we are safely in a region  $R$ , taking derivatives of with respect to  $z$  commutes with the limit  $V \rightarrow \infty$ . In other words, we are allowed to use (5.44) to write the particle density  $n = N/V$  as

$$\lim_{V \rightarrow \infty} n = \lim_{V \rightarrow \infty} z \frac{\partial}{\partial z} \left( \frac{p}{k_B T} \right) = z \frac{\partial \Theta}{\partial z}$$

However, if we look at points  $z$  where zeros appear on the positive real axis, then  $\Theta$  will generally not be analytic. If  $d\Theta/dz$  is discontinuous, then the system is said to undergo a first order phase transition. More generally, if  $d^m\Theta/dz^m$  is discontinuous for  $m = n$ , but continuous for all  $m < n$ , then the system undergoes an  $n^{\text{th}}$  order phase transition. We won't offer a proof of the Lee-Yang theorem. Instead illustrate the general idea with an example.

### A Made-Up Example

Ideally, we would like to start with a Hamiltonian which exhibits a first order phase transition, compute the associated grand partition function  $\mathcal{Z}$  and then follow its zeros as  $V \rightarrow \infty$ . However, as we mentioned above, that's hard! Instead we will simply make up a partition function  $\mathcal{Z}$  which has the appropriate properties. Our choice is somewhat artificial,

$$\mathcal{Z}(z, V) = (1 + z)^{[\alpha V]}(1 + z^{[\alpha V]})$$

Here  $\alpha$  is a constant which will typically depend on temperature, although we'll suppress this dependence in what follows. Also,

$$[x] = \text{Integer part of } x$$

Although we just made up the form of  $\mathcal{Z}$ , it does have the behaviour that one would expect of a partition function. In particular, for finite  $V$ , the zeros sit at

$$z = -1 \quad \text{and} \quad z = e^{\pi i(2n+1)/[\alpha V]} \quad n = 0, 1, \dots, [\alpha V] - 1$$

As promised, none of the zeros sit on the positive real axis. However, as we increase  $V$ , the zeros become denser and denser on the unit circle. From the Lee-Yang theorem, we expect that no phase transition will occur for  $z \neq 1$  but that something interesting could happen at  $z = 1$ .

Let's look at what happens as we send  $V \rightarrow \infty$ . We have

$$\begin{aligned} \Theta &= \lim_{V \rightarrow \infty} \frac{1}{V} \log \mathcal{Z}(z, V) \\ &= \lim_{V \rightarrow \infty} \frac{1}{V} ([\alpha V] \log(1 + z) + \log(1 + z^{[\alpha V]})) \\ &= \begin{cases} \alpha \log(1 + z) & |z| < 1 \\ \alpha \log(1 + z) + \alpha \log z & |z| > 1 \end{cases} \end{aligned}$$

We see that  $\Theta$  is continuous for all  $z$  as promised. But it is only analytic for  $|z| \neq 1$ .



We can extract the physics by using (5.43) and (5.44) to eliminate the dependence on  $z$ . This gives us the equation of state, with pressure  $p$  as a function of  $n = V/N$ . For  $|z| < 1$ , we have

$$p = \alpha k_B T \log \left( \frac{\alpha}{\alpha - n} \right) \quad n \in [0, \alpha/2) \quad , \quad p < k_B T \log 2$$

While for  $|z| > 1$ , we have

$$p = \alpha k_B T \log \left( \frac{2\alpha n}{(2\alpha - n)^2} \right) \quad n \in (3\alpha/2, 2\alpha) \quad , \quad p > k_B T \log 2$$

The key point is that there is a jump in particle density of  $\Delta n = \alpha$  at  $p = \alpha k_B T \log 2$ . Plotting this as a function of  $p$  vs  $v = 1/n$ , we find that we have a curve that is qualitatively identical to the pressure-volume plot of the liquid-gas phase diagram under the co-existence curve. (See, for example, figure 38). This is a first order phase transition.

## 5.5 Landau-Ginzburg Theory

Landau's theory of phase transition focusses only on the average quantity, the order parameter. It ignores the fluctuations of the system, assuming that they are negligible. Here we sketch a generalisation which attempts to account for these fluctuations. It is known as Landau-Ginzburg theory.

The idea is to stick with the concept of the order parameter,  $m$ . But now we allow the order parameter to vary in space so it becomes a function  $m(\vec{r})$ . Let's restrict ourselves to the situation where there is a symmetry of the theory  $m \rightarrow -m$  so we need only consider even powers in the expansion of the free energy. We add to these a gradient term whose role is to capture the fact that there is some stiffness in the system, so it costs energy to vary the order parameter from one point to another. (For the example of the Ising model, this is simply the statement that nearby spins want to be aligned). The free energy is then given by

$$F[m(\vec{r})] = \int d^d r \left[ a(T)m^2 + b(T)m^4 + c(T)(\nabla m)^2 \right] \quad (5.45)$$

where we have dropped the constant  $F_0(T)$  piece which doesn't depend on the order parameter and hence plays no role in the story. Notice that we start with terms quadratic in the gradient: a term linear in the gradient would violate the rotational symmetry of the system.

We again require that the free energy is minimised. But now  $F$  is a functional – it is a function of the function  $m(\vec{r})$ . To find the stationary points of such objects we need to use the same kind of variational methods that we use in Lagrangian mechanics. We write the variation of the free energy as

$$\begin{aligned}\delta F &= \int d^d r \left[ 2am \delta m + 4bm^3 \delta m + 2c \nabla m \cdot \nabla \delta m \right] \\ &= \int d^d r \left[ 2am + 4bm^3 - 2c \nabla^2 m \right] \delta m\end{aligned}$$

where to go from the first line to the second we have integrated by parts. (We need to remember that  $c(T)$  is a function of temperature but does not vary in space so that  $\nabla$  doesn't act on it). The minimum of the free energy is then determined by setting  $\delta F = 0$  which means that we have to solve the Euler-Lagrange equations for the function  $m(\vec{r})$ ,

$$c \nabla^2 m = am + 2bm^3 \tag{5.46}$$

The simplest solutions to this equation have  $m$  constant, reducing us back to Landau theory. We'll assume once again that  $a(T) > 0$  for  $T > T_c$  and  $a(T) < 0$  for  $T < T_c$ . Then the constant solutions are  $m = 0$  for  $T < T_c$  and  $m = \pm m_0 = \pm \sqrt{-a/2b}$  for  $T < T_c$ . However, allowing for the possibility of spatial variation in the order parameter also opens up the possibility for us to search for more interesting solutions.

## Domain Walls

Suppose that we have  $T < T_c$  so there exist two degenerate ground states,  $m = \pm m_0$ . We could cook up a situation in which one half of space, say  $x < 0$ , lives in the ground state  $m = -m_0$  while the other half of space,  $x > 0$  lives in  $m = +m_0$ . This is exactly the situation that we already met in the liquid-gas transition and is depicted in Figure 38. It is also easy to cook up the analogous configuration in the Ising model. The two regions in which the spins point up or down are called domains. The place where these regions meet is called the *domain wall*.

We would like to understand the structure of the domain wall. How does the system interpolate between these two states? The transition can't happen instantaneously because that would result in the gradient term  $(\nabla m)^2$  giving an infinite contribution to the free energy. But neither can the transition linger too much because any point at which  $m(\vec{r})$  differs significantly from the value  $m_0$  costs free energy from the  $m^2$  and  $m^4$  terms. There must be a happy medium between these two.

To describe the system with two domains,  $m(\vec{r})$  must vary but it need only change in one direction:  $m = m(x)$ . Equation (5.46) then becomes an ordinary differential equation,

$$\frac{d^2m}{dx^2} = \frac{am}{c} + \frac{2bm^3}{c}$$

This equation is easily solved. We should remember that in order to have two vacua,  $T < T_c$  which means that  $a < 0$ . We then have

$$m = m_0 \tanh \left( \sqrt{\frac{-a}{2c}} x \right)$$

where  $m_0 = \sqrt{-a/2b}$  is the constant ground state solution for the spin. As  $x \rightarrow \pm\infty$ , the tanh function tends towards  $\pm 1$  which means that  $m \rightarrow \pm m_0$ . So this solution indeed interpolates between the two domains as required. We learn that the width of the domain wall is given by  $\sqrt{-2c/a}$ . Outside of this region, the magnetisation relaxes exponentially quickly back to the ground state values.

We can also compute the cost in free energy due to the presence of the domain wall. To do this, we substitute the solution back into the expression for the free energy (5.45). The cost is not proportional to the volume of the system, but instead proportional to the area of the domain wall. This means that if the system has linear size  $L$  then the free energy of the ground state scales as  $L^d$  while the free energy required by the wall scales only as  $L^{d-1}$ . It is simple to find the parametric dependence of this domain wall energy without doing any integrals; the energy per unit area scales as  $\sqrt{-ca^3/b}$ . Notice that as we approach the critical point, and  $a \rightarrow 0$ , the two vacua are closer, the width of the domain wall increases and its energy decreases.

### 5.5.1 Correlations

One of the most important applications of Landau-Ginzburg theory is to understand the correlations between fluctuations of the system at different points in space. Suppose that we know that the system has an unusually high fluctuation away from the average at some point in space, let's say the origin  $\vec{r} = 0$ . What is the effect of this on nearby points?

There is a simple way to answer this question that requires us only to solve the differential equation (5.46). However, there is also a more complicated way to derive the same result which has the advantage of stressing the underlying physics and the role played by fluctuations. Below we'll start by deriving the correlations in the simple manner. We'll then see how it can also be derived using more technical machinery.

We assume that the system sits in a given ground state, say  $m = +m_0$ , and imagine small perturbations around this. We write the magnetisation as

$$m(\vec{r}) = m_0 + \delta m(\vec{r}) \quad (5.47)$$

If we substitute this into equation (5.46) and keep only terms linear in  $\delta m$ , we find

$$c\nabla^2\delta m + \frac{2a}{c}\delta m = 0$$

where we have substituted  $m_0^2 = -a/2b$  to get this result. (Recall that  $a < 0$  in the ordered phase). We now perturb the system. This can be modelled by putting a delta-function source at the origin, so that the above equation becomes

$$c\nabla^2\delta m + \frac{2a}{c}\delta m = \frac{1}{2c}\delta^d(0)$$

where the strength of the delta function has been chosen merely to make the equation somewhat nicer. This equation is straightforward to solve. Indeed, it is the same kind of equation that we already solved when discussing the Debye-Hückel model of screening. Neglecting constant factors (2's and  $\pi$ 's) it is

$$\delta m(\vec{r}) \sim \frac{e^{-r/\xi}}{c^{d-2}} \quad (5.48)$$

This tells us how the perturbation decays as we move away from the origin. This equation has several names, reflecting the fact that it arises in many contexts. In liquids, it is usually called the *Ornstein-Zernicke* correlation. It also arises in particle physics as the Yukawa potential. The length scale  $\xi$  is called the *correlation length*

$$\xi = \sqrt{\frac{-c}{2a}} \quad (5.49)$$

The correlation length provides a measure of the distance it takes correlations to decay. Notice that as we approach a critical point,  $a \rightarrow 0$  and the correlation length diverges. This provides yet another hint that we need more powerful tools to understand the physics at the critical point. We will now take the first baby step towards developing these tools.

### 5.5.2 Fluctuations

The main motivation to allow the order parameter to depend on space is to take into the account the effect of fluctuations. To see how we can do this, we first need to think a little more about the meaning of the quantity  $F[m(\vec{r})]$  and what we can use it for.

To understand this point, it's best if we go back to basics. We know that the true free energy of the system can be equated with the log of the partition function (1.36). We'd like to call the true free energy of the system  $F$  because that's the notation that we've been using throughout the course. But we've now called the Landau-Ginzburg functional  $F[m(\vec{r})]$  and, while it's closely related to the true free energy, it's not quite the same thing as we shall shortly see. So to save some confusion, we're going to change notation at this late stage and call the true free energy  $A$ . Equation (1.36) then reads  $A = -k_B T \log Z$ , which we write this as

$$e^{-\beta A} = Z = \sum_n e^{-\beta E_n}$$

We would like to understand the right way to view the functional  $F[m(\vec{r})]$  in this framework. Here we give a heuristic and fairly handwaving argument. A fuller treatment involves the ideas of the renormalisation group.

The idea is that each microstate  $|n\rangle$  of the system can be associated to some specific function of the spatially varying order parameter  $m(\vec{r})$ . To illustrate this, we'll talk in the language of the Ising model although the discussion generalises to any system. There we could consider associate a magnetisation  $m(\vec{r})$  to each lattice site by simply averaging over all the spins within some distance of that point. Clearly, this will only lead to functions that take values on lattice sites rather than in the continuum. But if the functions are suitably well behaved it should be possible to smooth them out into continuous functions  $m(\vec{r})$  which are essentially constant on distance scales smaller than the lattice spacing. In this way, we get a map from the space of microstates to the magnetisation,  $|n\rangle \mapsto m(\vec{r})$ . But this map is not one-to-one. For example, if the averaging procedure is performed over enough sites, flipping the spin on just a single site is unlikely to have much effect on the average. In this way, many microstates map onto the same average magnetisation. Summing over just these microstates provides a first principles construction of the  $F[m(\vec{r})]$ ,

$$e^{-\beta F[m(\vec{r})]} = \sum_{n|m(\vec{r})} e^{-\beta E_n} \quad (5.50)$$

Of course, we didn't actually perform this procedure to get to (5.45): we simply wrote it down the most general form in the vicinity of a critical point with a bunch of unknown coefficients  $a(T)$ ,  $b(T)$  and  $c(T)$ . But if we were up for a challenge, the above procedure tells us how we could go about figuring out those functions from first principles. More importantly, it also tells us what we should do with the Landau-Ginzburg free energy. Because in (5.50) we have only summed over those states that correspond to a particular

value of  $m(\vec{r})$ . To compute the full partition function, we need to sum over all states. But we can do that by summing over all possible values of  $m(\vec{r})$ . In other words,

$$Z = \int Dm(\vec{r}) e^{-\beta F[m(\vec{r})]} \quad (5.51)$$

This is a tricky beast: it is a *functional integral*. We are integrating over all possible function  $m(\vec{r})$ , which is the same thing as performing an infinite number of integrations. (Actually, because the order parameters  $m(\vec{r})$  arose from an underlying lattice and are suitably smooth on short distance scales, the problem is somewhat mitigated).

The result (5.51) is physically very nice, albeit mathematically somewhat daunting. It means that we should view the Landau-Ginzburg free energy as a new effective Hamiltonian for a continuous variable  $m(\vec{r})$ . It arises from performing the partition function sum over much of the microscopic information, but still leaves us with a final sum, or integral, over fluctuations in an averaged quantity, namely the order parameter.

To complete the problem, we need to perform the function integral (5.51). This is *hard*. (Here “hard” means that the majority of unsolved problems in theoretical physics can be boiled down to performing integrals of this type). We will proceed with an approximation. As in our discussion of correlations above, we assume that we sit in the ground state  $m = +m_0$  and can consider small thermal fluctuations  $\delta m(\vec{r})$  around this state (5.47). We then expand the free energy (5.45) to quadratic order, dropping all terms of order  $\delta m^3$  or higher,

$$F[m(\vec{r})] = \int d^d r \left[ am_0^2 + 2am_0\delta m + a\delta m^2 + bm_0^4 + 4bm_0^3\delta m + 6bm_0^2\delta m^2 + c(\nabla\delta m)^2 \right]$$

The constant terms simply reproduce the free energy of the ground state. Importantly, the linear terms vanish when we substitute in the value  $m_0 = \sqrt{-a/2b}$ . In fact, this was guaranteed to happen: the vanishing of the linear terms is equivalent to the requirement that the equation (5.46) is obeyed. We’re left just with the quadratic terms. To make life easier with minus signs, we define  $a' = a + 6bm_0^2 = -2a > 0$  and the fluctuation contribution to the free energy becomes

$$F[m(\vec{r})] = F[m_0] + \int d^d r \left[ a'\delta m^2 + c(\nabla\delta m)^2 \right]$$

If we now plug this form into the functional integral (5.51), the partition function becomes

$$Z = e^{-\beta F[m_0]} \int D[\delta m(\vec{r})] \exp \left( -\beta \int d^d r \left[ a'\delta m^2 + c(\nabla\delta m)^2 \right] \right) \quad (5.52)$$

Writing the partition function in this form gives us room for optimism. We still have to perform a functional integral, but now it's an integral of the Gaussian type. And we think that we know how to do Gaussian integrals. The fact that it's a functional integral merely means that we have to do an infinite number of them.

### Free Energy

Before we explain how to perform the integral in (5.52), it's worth pausing to point out that this expression clarifies the relationship between the true free energy of the system, which we're now calling  $A$  and is defined by  $Z = e^{-\beta A}$ , and the Landau-Ginzburg functional  $F[m(\vec{r})]$ . If our approximation is good, then the functional integral in (5.52) will give an expression that is close to 1. Then we have

$$A \approx F[m_0]$$

Performing the functional integral in (5.52) will give corrections to this result. Including terms of order  $\delta m(\vec{r})^3$  and higher will give yet further corrections.

So, our goal is to now perform the integrals in (5.52). As mentioned above, they are Gaussian. But they are complicated somewhat by the presence of the derivative operator  $\nabla$  in the exponent. But it turns out that this is easy to deal with: we simply need to write the fluctuations as a Fourier transform over momentum. If the system lives in a box with sides of length  $L$ , the Fourier transform is

$$\delta m_{\vec{k}} = \frac{1}{L^{d/2}} \int d^d r e^{-i\vec{k}\cdot\vec{r}} \delta m(\vec{r})$$

Note that because  $\delta m(\vec{r})$  is real, we must have  $\delta m_{\vec{k}}^* = \delta m_{-\vec{k}}$ . The momenta  $\vec{k}$  are quantised as

$$\vec{k} = \frac{2\pi}{L} \vec{n}$$

where  $\vec{n}$  has integer valued components. We can always get back to the spatial fluctuations by taking the inverse Fourier transform,

$$\delta m(\vec{r}) = \frac{1}{L^{d/2}} \sum_{\vec{k}} e^{i\vec{k}\cdot\vec{r}} \delta m_{\vec{k}}$$

Substituting this expression into the free energy, we get

$$F[m(\vec{r})] = F[m_0] + \frac{1}{L^d} \sum_{\vec{k}} \sum_{\vec{k}'} \left( a' - c \vec{k} \cdot \vec{k}' \right) \delta m_{\vec{k}} \delta m_{\vec{k}'} \int d^d r e^{i(\vec{k}+\vec{k}')\cdot\vec{r}}$$

The integral over space gives the delta-function  $L^d \delta(\vec{k} + \vec{k}')$  and we can write the fluctuation contribution to the free energy in momentum space as

$$\begin{aligned} F[m(\vec{r})] &= F[m_0] + \sum_{\vec{k}} (a' + ck^2) \delta m_{\vec{k}} \delta m_{-\vec{k}} \\ &= F[m_0] + \sum_{\vec{k}} (a' + ck^2) \delta m_{\vec{k}} \delta m_{\vec{k}}^* \end{aligned}$$

We substitute this into the partition function (5.52) and change the integration measure from  $\delta m(\vec{r})$  to the Fourier mode  $\delta m_{\vec{k}}$ . The net result is that the functional integral turns into a standard integral over  $\delta m_{\vec{k}}$  for each value of the momentum  $\vec{k}$ . Moreover, as promised, each of these integrals is simply Gaussian. Which means that we can do them,

$$\begin{aligned} Z &= e^{-\beta F[m_0]} \prod_{\vec{k}} \int d\delta m_{\vec{k}} d\delta m_{\vec{k}}^* \exp(-\beta(a' + ck^2) \delta m_{\vec{k}} \delta m_{\vec{k}}^*) \\ &= e^{-\beta F[m_0]} \prod_{\vec{k}} \frac{\pi k_B T}{a' + ck^2} \end{aligned} \quad (5.53)$$

This means that we can write the true free energy of the system as

$$\begin{aligned} A &= F[m_0] - \frac{k_B T}{2} \sum_{\vec{k}} \log \left( \frac{\pi k_B T}{a' + ck^2} \right) \\ &= F[m_0] - \frac{k_B T}{2} L^d \int \frac{d^d k}{(2\pi)^d} \log \left( \frac{\pi k_B T}{a' + ck^2} \right) \end{aligned} \quad (5.54)$$

Given the free energy, one usually computes the contribution to the heat capacity due to the fluctuations. However, we will instead leave this particular thread hanging and instead return to the question of correlations.

## Correlations Revisited

We are now in a position to once again look at the spatial correlations between fluctuations. This information is captured in the *correlation function*  $\langle \delta m(\vec{r}) \delta m(0) \rangle$ . To calculate this, it is convenient to first relate it to an associated correlation function in momentum space through the Fourier transform,

$$\langle \delta m(\vec{r}) \delta m(0) \rangle = \frac{1}{L^d} \sum_{\vec{k}} \sum_{\vec{k}'} e^{i\vec{k} \cdot \vec{r}} \langle \delta m_{\vec{k}} \delta m_{\vec{k}'} \rangle$$



We can compute the correlation in momentum space through the partition function (5.53). The relevant integral is

$$\begin{aligned}\langle \delta m_{\vec{k}} \delta m_{\vec{k}'} \rangle &= \frac{e^{-\beta F[m_0]}}{Z} \prod_{\vec{k}''} \int d\delta m_{\vec{k}''} d\delta m_{-\vec{k}''} (\delta m_{\vec{k}} \delta m_{\vec{k}'}) \exp(-\beta(a' + c(k'')^2) \delta m_{\vec{k}''} \delta m_{-\vec{k}''}) \\ &= \frac{k_B T}{a' + ck^2} \delta_{\vec{k} + \vec{k}'}\end{aligned}$$

With this in hand, it is a simple matter to compute the spatial correlations,

$$\begin{aligned}\langle \delta m(\vec{r}) \delta m(0) \rangle &= \frac{1}{L^d} \sum_{\vec{k}} e^{i\vec{k} \cdot \vec{r}} \frac{k_B T}{a' + ck^2} \\ &\approx \int \frac{d^d k}{(2\pi)^d} e^{i\vec{k} \cdot \vec{r}} \frac{k_B T}{a' + ck^2} \\ &\sim \frac{e^{-r/\xi}}{r^{d-2}}\end{aligned}$$

This reproduces the result (5.48), with the correlation length  $\xi$  again given by (5.49).

## The Upper Critical Dimension

One of the advantages of treating the fluctuations correctly using the functional integral is that it allows us to learn when they can be safely neglected, so that the mean field approach of the Landau-Ginzburg equation (5.46) is sufficient to capture the physics. Roughly speaking, we require that the size of the fluctuations over any region of space is much smaller than the mean-field value: in other words,  $\langle \delta m^2 \rangle \ll \langle m \rangle^2$

We have already seen that the fluctuations decay after a distance  $\xi$ , so we can gain a measure of their importance if we integrate over a ball of radius  $\xi$ , namely

$$\frac{\int_0^\xi d^d r \langle \delta m(\vec{r}) \delta m(0) \rangle}{\int_0^\xi d^d r m_0^2} \sim \frac{\xi^{2-d}}{m_0^2}$$

In order to trust mean field theory, we require that this ratio is much less than one. This is the *Ginzburg criterion*. We can anticipate trouble as we approach a critical point, for here  $\xi$  diverges and  $m_0$  vanishes. The precise scaling of these two quantities is  $\xi = \sqrt{-c/2a}$  and  $m_0 = \sqrt{-a/2b}$  where  $a \rightarrow 0$  as we approach the critical point.

We learn that this ratio vanishes as we approach a critical point in dimensions  $d > 4$ . It diverges in dimensions  $d < 4$ . Dimension  $d = 4$  is referred to as the *upper critical dimension*. Above this, mean field theory is trustworthy. Indeed, we mentioned in the

discussion of the Ising model that the mean field critical exponents give the correct answer only for  $d \geq 4$ . Below the upper critical dimension, mean field theory does not give quantitatively correct answers. We have to work much harder. But we will postpone that hard work for another course.